

A woman is shown from the chest up, standing under a shower. She has her eyes closed and a serene expression, with her hands resting on her neck and shoulders. Water is spraying over her head and shoulders, creating a misty atmosphere. The background is a dark, textured wall, possibly marble. The overall mood is one of relaxation and natural beauty.

**hansgrohe**

# **Meet the beauty of water**

The showering and tap collection 2020



# hansgrohe: modern design and refreshingly high-quality products

## **Showering perfection since 1901**

With constant emphasis on the highest standards, our visionary concepts help make life in the bathroom easier, better and more beautiful. Our determination to enhance the beauty of water and every aspect of your experience knows no bounds. Innovation combined with brilliantly simple, ultra-reliable technology ensures we create timeless and sophisticated products. All over the world, hansgrohe is synonymous with high-quality products of exceptional design, ease of use and intelligent functionality.

## **Engineered in Germany**

Since 1901, 'Engineered in Germany' has been a recipe for success for Hansgrohe as a shower and tap manufacturer. Over 119 years since the company's foundation, this level of German expertise is a guarantee of excellence. Every Hansgrohe manufacturing facility works to the highest standards through continuous quality management to ensure top performing products and service.

## **Our name is your guarantee**

Always creating the highest quality products defines our approach to modern design, manufacturing and performance. 'Made by Hansgrohe' is your assurance of quality, backed by our five-year guarantee for repair, replacement or refund if ever any of our products fail to fulfil those high expectations that attracted you to the Hansgrohe name.



All products carry a minimum 5 year manufacturing guarantee.



Spare parts held for 15 years after product discontinuation.



## Discovering hansgrohe

---

- 6** Designed for life, realised by hansgrohe
- 8** Quality that you can count on
- 10** Our commitment to a sustainable future
- 11** Experience the world of comfort
- 12** NEW products - FinishPlus
- 14** We don't just keep up with technology - we pioneer it
- 18** Experience showering like never before

## Discover your perfect shower

---

- 22** Create a shower as individual as you are
- 24** Showering product overview

## The hansgrohe selections

---

- 32** Concealed valve with overhead shower and slide rail kit
- 36** Concealed valve with overhead shower and hand shower holder
- 40** Concealed valve with slide rail kit
- 44** Concealed valve with overhead shower
- 48** Concealed valve with slide rail kit and Exafill overflow bath filler
- 52** Exposed valve with slide rail kit
- 56** Exposed bath/shower valve with slide rail kit
- 60** Showerpipes: all-in-one shower system

## hansgrohe: style on tap

---

- 64** Taps
- 69** Accessories

## Installing hansgrohe

---

- 70** Peace of mind from installation to enjoyment

**Product shown:** Round valve with Cromo Select (180) overhead (88101022)



## Designed for life, realised by Hansgrohe

At Hansgrohe our philosophy of design is integral to everything you see and defines the standard to which others can only aspire.

### Clever minds and new designs

Bathrooms are living spaces where we can feel comfortable and cultivate our own individual style. hansgrohe products are meticulously designed and manufactured to make them more attractive, more comfortable and more exhilarating. Working closely with a number of the world's most influential designers, Hansgrohe leads the bathroom industry in both aesthetics and performance.

### Defining excellence

By collaborating with internationally recognised creative minds, we empower, endow, direct and define global design. Our showers, shower systems and taps have won more than 600 internationally renowned awards including in competitions organised by the universally respected International Forum Design (iF). Determined by independent judging panels, iF awards are among the most prestigious and largest in the design world.

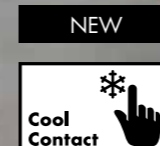



## Hansgrohe: quality that you can count on

At Hansgrohe we create top quality products that deliver in both form and function, so you can enjoy them for a long time to come.

We apply rigorous tests and stringent guidelines in our development and production, and that's validated by the independent testing institutes that attest to our high quality workmanship.

### **Quality is infused into every hansgrohe product**

Before our products are ready for production, they have to prove themselves thousands of times in test cycles, stress tests, and field tests. Highly qualified employees see to meticulous quality assurance and quality management at every point.

### **Manufacturing quality**

Hansgrohe relies on top-quality materials, high-tech design and precision work. But Hansgrohe understands "quality workmanship" to mean more than just the materials. It's the basis of our four pillars of quality: product, design, manufacturing and service.



All products carry a minimum 5 year manufacturing guarantee.



Spare parts held for 15 years after product discontinuation.

# Our commitment to sustainable future

At Hansgrohe, green is not just our company colour but a true reflection of how seriously we consider the environment we all live in and climate protection.

Sustainability is a goal we continually strive for. As a Hansgrohe customer, choosing any one of our bathroom products means you are championing long-lasting quality created using environmentally responsible production methods. All designed to help conserve our planet's valuable resources.

### Lower emissions, lower costs

EcoSmart is our own innovative technology that is hidden within a selection of hansgrohe showers and taps. It ensures they consume up to 60% less water than conventional products without compromising your experience. Moreover, meaning lower hot water consumption and therefore reducing energy needs too. The end result? Lower carbon dioxide emissions and lower costs, good for the environment and good for your wallet.

### A green light for today and tomorrow

At Hansgrohe, we continue to align our manufacturing facilities to meet ecological demands and set high environmental standards for ourselves. Whenever possible, we use technologies in production that save water, energy and other resources. So you can be confident that your hansgrohe bathroom products will function reliably and economically, having been built to last, using high quality materials manufactured in environmentally responsible conditions.

60%

reduction in water consumption

CO<sub>2</sub>

emission essentially lowered

3ltr

less water consumption per minute

# Experience the world of comfort

In over 140 countries globally, Hansgrohe has defined comfort through design, reshaping the culture of the modern bathroom. Headquartered at Schiltach in the heart of the Black Forest, we are represented on every continent.

All over the world, developers and investors work hand in hand with architects and planners on sophisticated projects. They are constantly in need of intelligent and aesthetically appealing solutions to maximise the beauty of water. hansgrohe showers and taps continue to define design and comfort in impressive hotels and public buildings, private residences, exclusive sports clubs, cruise ships and luxury yachts the world over.



- 1. Hotel Excelsior (Dubrovnik)**  
Talis S single lever basin tap,  
Talis S single bath tap floor-standing,  
Crometta S 240 1jet overhead shower
- 2. NUO Hotel Beijing (Peking)**  
PuraVida single lever bath tap floor-standing,  
Raindance S 300 Air 1jet overhead shower
- 3. Prive at Island Estates (Florida)**  
Croma 220 overhead shower,  
Metris 100 single lever basin tap,  
PuraVida hand shower  
Raindance S 100 3jet
- 4. 19 Park Place (New York)**  
Croma 220 showerhead  
Raindance S 100 3jet



# Express your personality with FinishPlus.

New for 2020. Individuality with a splash of colour.

Add character to your bathroom with new FinishPlus for your basin, bath or shower. In our two best-selling tap ranges – Metropol and Talis E – there is now the choice between chrome and five new surface finish designs to give your bathroom a certain je ne sais quoi. The matt black and matt white surface finishes are perfect for fans of modern architecture, while the premium metallic surface finishes with polished gold optic, brushed black chrome and brushed bronze combine elegance and modern flair. Please speak to your showroom consultant for product availability.



**Matt White**



**Matt Black**



**Brushed Black Chrome**



**Polished Gold Optic**



**Brushed Bronze**



**Chrome**

# We don't just keep up with technology - we pioneer it

Our innovative technologies are all about performance. To enhance the beauty of water and every aspect of your enjoyment.

From the big picture to the smallest detail, we welcome every opportunity to enhance your showering experience by integrating technical innovation wherever and whenever it will function best. The icons are here to introduce you to the latest hansgrohe advances. They are your guide to discovering just how much hansgrohe can enhance your comfort and enjoyment in the bathroom.



### Less water, less energy, more enjoyment

EcoSmart technology reduces your water consumption by up to 60% without compromising on your showering performance. Thanks to a sophisticated flow limiter, special jets and integrated aerator, you not only save precious water but also the energy needed to heat it. That's good news for the planet and good news for your wallet too.

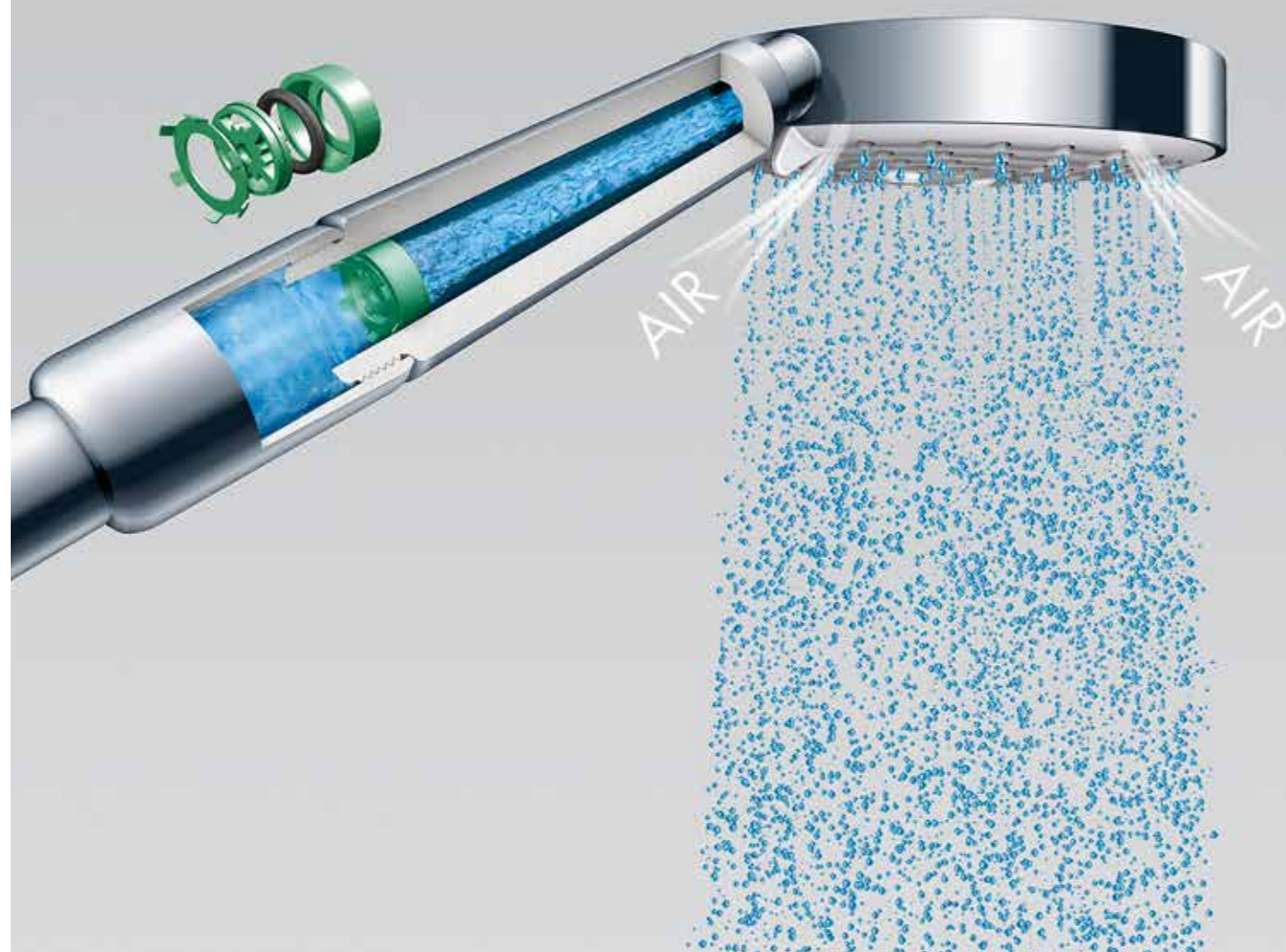

### Soothing sensations

Introducing carefree showers. CoolContact prevents the thermostatic mixer from getting too hot and prevents painful scalding.



### Comfort and convenience at your fingertips

One touch changes the waterflow. The shower or spray type can be switched on and off or changed with a simple click.



### Limescale simply rubbed off in an instant

Remove limescale deposits simply by rubbing the flexible silicone nozzles.

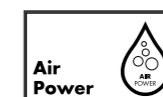

### More volume, more pleasure

Combines water with a generous amount of air. For a soft, splash-free water spray and rich, full shower drops.

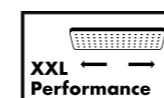

### Big performance, great experience

Evenly distributes the water over the large spray face to envelope the whole body.

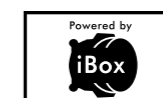

### The hidden magic behind our showers

The ultra-reliable, flexible device that is behind your shower's superb performance.



# Comfort and control at your fingertips

In a hansgrohe shower, the water temperature is always just right so you can relax and enjoy its stimulating sensations from beginning to end.

A thermostatic shower mixer valve is a necessary part of a high-quality shower. Safe, automatic and efficient, it ensures maximum showering satisfaction whilst protecting you and your family from the risk of scalding.

## What is a thermostatic shower mixer valve?

A thermostatic shower mixer valve maintains an exact water temperature throughout your shower. Should you wish to stop the water, it will automatically find the exact same temperature when you turn it on again. It protects you from any unexpected changes in the water supply to the shower, so even if somebody flushes the toilet or turns on a tap, the water temperature will stay the same.

## How does it work?

The thermostatic shower mixer valve mixes the hot and cold water to your pre-selected temperature and reacts instantly to any changes in the pressure or temperature of the water supply by re-adjusting the mix of hot and cold water. Should there be a failure in your cold water supply, the thermostatic valve will automatically shut down.



hansgrohe thermostatic shower mixer valves are available for both concealed and exposed installations

# Revolutionise your daily shower with PowderRain®

Nine out of ten consumers said they wouldn't return to their old hand showers after experiencing PowderRain®.\*

Enjoy a new dimension in showering with hansgrohe PowderRain®. The fine droplets inspired by the rainforest provide a deeply relaxing showering experience.



## A showering sensation

At the touch of a button, you will experience in an instant the velvety-soft sensation that is PowderRain. In place of one single spray outlet for each nozzle, PowderRain uncovers six ultra-fine openings that transform its generous spray into thousands of incredibly light micro droplets that gently fall on the skin without bouncing off.



\*Source: TRND Survey  
1,500 consumer test users  
- Dec '18

# Experience showering like never before

Invigoring. Indulgent. Relaxing. Energising. Everyone has their own idea of the most rewarding showering experience. Throughout this brochure the Spray Pattern icons shown will help navigate your choice of hansgrohe shower that delivers the patterns of your choice from a brisk burst of freshness to softly soothing massage.



**PowderRain**  
A unique shower experience thanks to the soft caress of micro droplets.



**Rain and Rain XL**  
Ideal for rinsing out shampoo quickly and thoroughly.

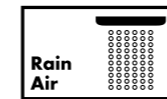

**RainAir**  
Air-enriched drops from a large, wide jet to wash your cares away.



**Intense Rain**  
Invigorate your muscles and set yourself up for the day with the powerful IntenseRain water spray.



**Turbo Rain**  
The all-purpose tool for quick results: the revitalising spray lives up to its name.



**Soft Rain**  
The gentle SoftRain water spray gently wraps itself around the body. A treat for the skin – and for the soul.



**Massage**  
A concentrated spray, creating a wellness treatment for the home bathroom.

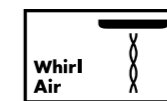

**Whirl Air**  
The concentrated WhirlAir spray simply massages away the exertions of the day.

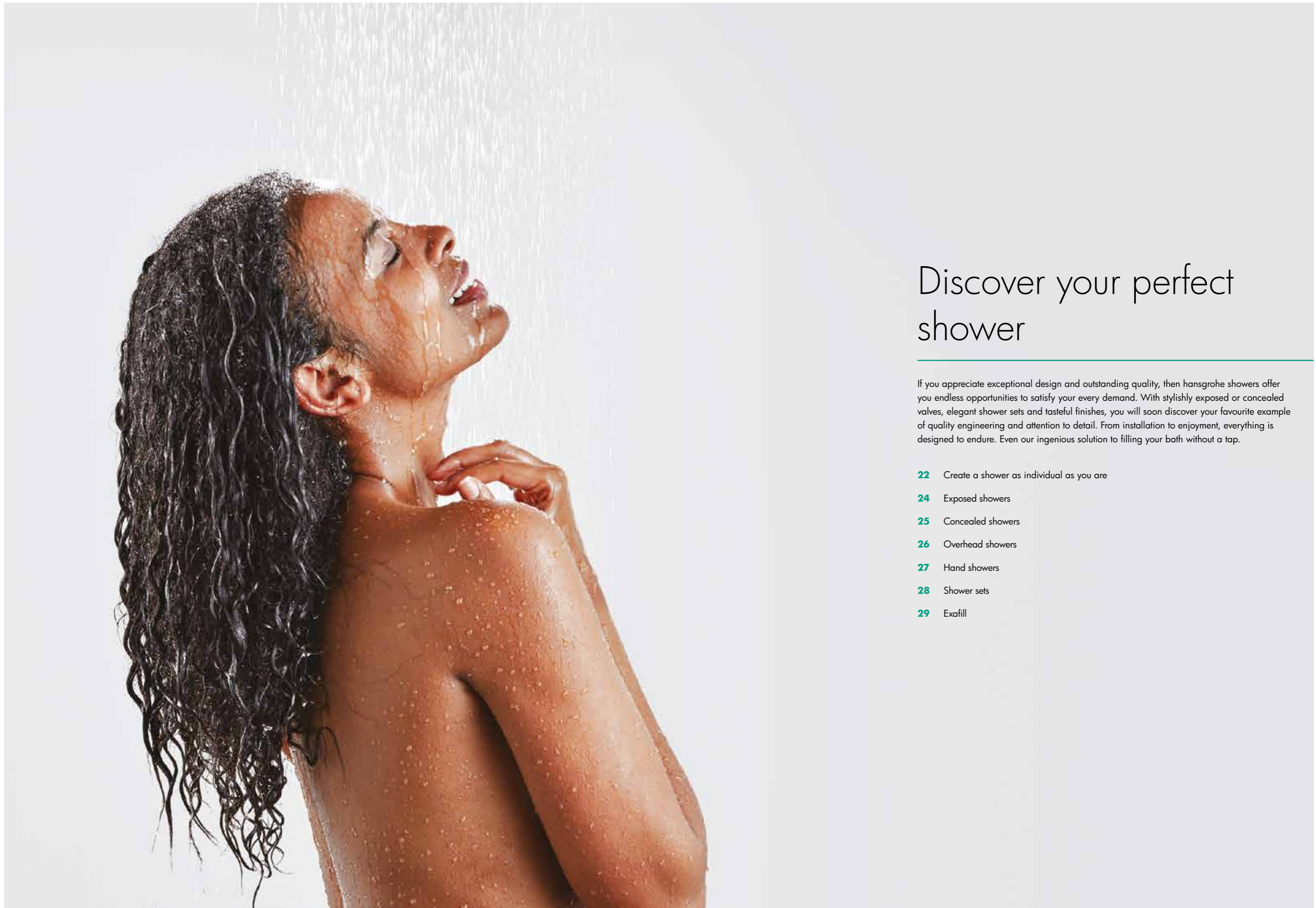

## Discover your perfect shower

---

If you appreciate exceptional design and outstanding quality, then hansgrohe showers offer you endless opportunities to satisfy your every demand. With stylishly exposed or concealed valves, elegant shower sets and tasteful finishes, you will soon discover your favourite example of quality engineering and attention to detail. From installation to enjoyment, everything is designed to endure. Even our ingenious solution to filling your bath without a tap.

- 22** Create a shower as individual as you are
- 24** Exposed showers
- 25** Concealed showers
- 26** Overhead showers
- 27** Hand showers
- 28** Shower sets
- 29** Exafill

# Create a shower as individual as you are

Here's how to choose the right hansgrohe products for the kind of space you want to create. After all, your shower should be as individual as you are. Simply select and identify the shower configuration you need to achieve the style and set-up you prefer together with the quality performance and control you demand.

## Concealed valve

Space-saving or sleekly minimalistic, a concealed valve hidden behind your tiling or wet wall fulfils the desire for a streamlined appearance by masking unattractive pipe work or fittings.

**Available in three beautiful shapes**



**Square (with Select)**



**Soft Cube**



**Round**

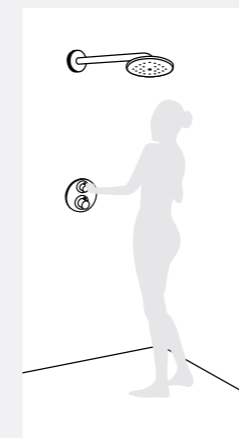

**Overhead shower**  
See page 44

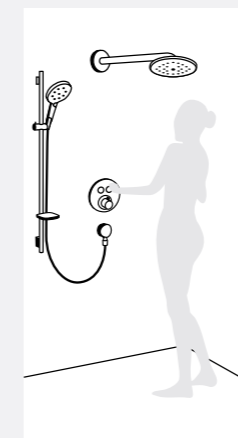

**Overhead shower with hand shower on slide rail**  
See page 32

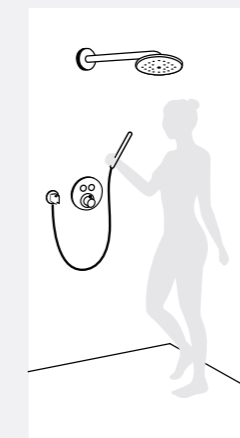

**Overhead shower with hand shower holder**  
See page 36

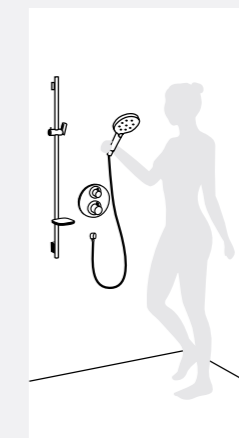

**Hand shower on slide rail**  
See page 40

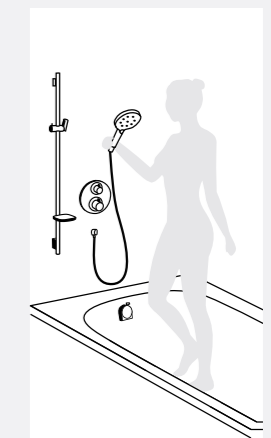

**Bath fill with Exafill and hand shower on slide rail**  
See page 48

## Exposed valve

Where solid brick walls don't allow a concealed valve or there is a desire to focus more on practicality and function, an exposed valve is often the preferred choice for traditional or classically styled bathrooms.



**Bath/shower valve**



**Shower valve**



**Hand shower on slide rail**  
See page 52

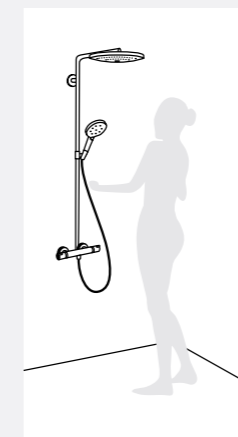

**Showerpipe**  
See page 60

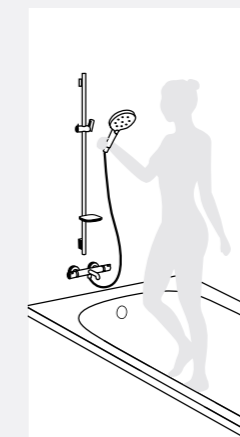

**Bath/shower valve with hand shower on slide rail**  
See page 56

# Exposed showers

hansgrohe offers a wide selection of exposed shower valves. These not only add glamour to your bathroom but improve your shower experience too. Their intuitive controls let you easily regulate the water volume, pressure and temperature. Be your own judge of the first-class, elegant design, amazing functionality and reliable hansgrohe quality.



**ShowerTablet**  
Select 300 shower mixer  
13171400



**ShowerTablet**  
Select 300 bath and shower mixer  
13151400

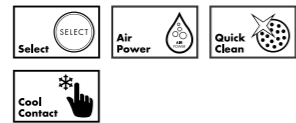

**ShowerTablet**  
Select 700 shower mixer  
13184000



**Ecostat**  
Comfort Care bath and shower mixer  
13115000



**Ecostat**  
Select shower mixer  
13161000



**ShowerTablet**  
350 shower mixer  
13102000



NEW



**Ecostat E**  
Shower mixer  
15773000



**Ecostat**  
Universal shower mixer  
13122000



**Ecostat**  
Comfort shower mixer  
13116000



# Concealed showers

hansgrohe's diverse range of concealed shower valves gives you enormous scope when designing your bathroom. You'll be surprised at how many functions and designs there are that not only look great but also create more space and can be combined with any hansgrohe shower head.



**ShowerSelect Glass**  
Shower mixer for 2 outlets  
15738600



**RainSelect**  
Shower mixer for 2 outlets  
15355000



**RainSelect**  
Shower mixer for 5 outlets  
15358000



**ShowerSelect S**  
Shower mixer for 1 outlet  
15744000



**ShowerSelect Glass**  
Valve for 3 outlets  
15736400



**ShowerSelect**  
Shower mixer for 2 outlets  
15763000



**Ecostat Square**  
Shower mixer for 1 outlet  
15712000



**Ecostat S**  
Shower mixer for 2 outlets  
15758000



**Ecostat E**  
Shower mixer for 2 outlets  
15708000

# Overhead showers

The hansgrohe range of overhead showers gives you the choice of square, soft cube or round heads, strikingly angular designs or softly rounded corners. They are available in chrome or an attractive combination of white and chrome.



**Raindance Select E**  
300 3jet overhead shower  
26468000

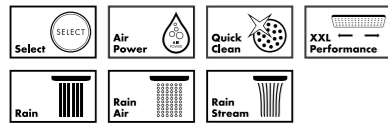

**Raindance Select**  
460 2jet overhead shower  
24005400

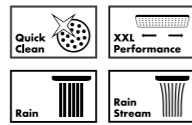

**Raindance Select**  
580 3jet overhead shower  
24001600

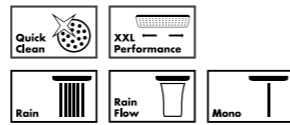

**Raindance Select S**  
240 2jet overhead shower  
26466400

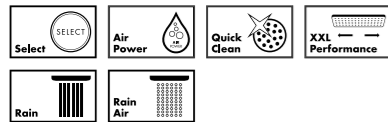

**Raindance S**  
240 1jet overhead shower  
27474000

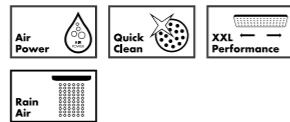

**Raindance E**  
300 1jet overhead shower  
26238000

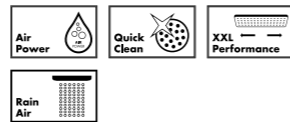

**Crometta E**  
240 1jet overhead shower  
26726000

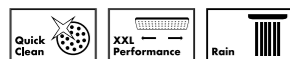

**Raindance E**  
240 1jet overhead shower  
27370000

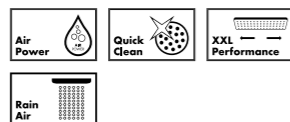

**Crometta E**  
280 1jet overhead shower  
26257000

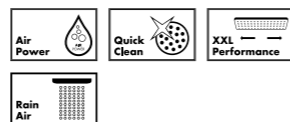

**NEW**

# Hand showers

Available in a square, soft cube or round design, our stunning hand showers not only feel good but look good too. As hansgrohe hand showers fit all shower hoses, upgrading your showering experience couldn't be easier.



**Raindance Select E**  
150 3jet hand shower  
26550400

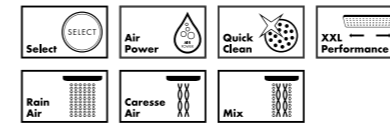

**Raindance Select S**  
150 3jet hand shower  
28587000

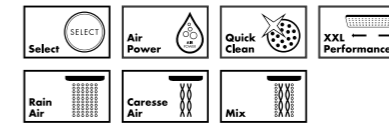

**PuraVida**  
150 3jet hand shower  
28557400

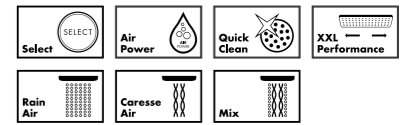

**Croma Select S**  
110 3jet multi hand shower  
26800400

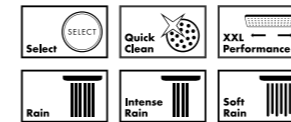

**Raindance Select E**  
120 3jet hand shower  
26520000



**Raindance Select S**  
120 3jet hand shower  
26530400



**Crometta**  
100 1jet hand shower  
26825400

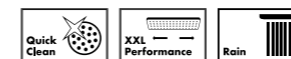

**Crometta**  
100 3jet multi hand shower  
26823400

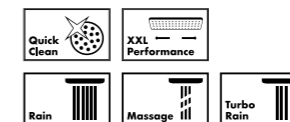

**Croma Select S**  
110 1jet hand shower  
26804400



# Shower sets

hansgrohe shower sets consist of a hand shower, shower rail and shower hose. They're convenient, unique and reliable combinations for your shower or bath. Ideal for any style of bathroom, they can be easily installed onto existing fittings or plumbing. And, as we offer different sets for virtually all our hand showers, you really are spoilt for choice.



**Raindance Select E**  
120 3jet shower set with 90cm shower rail  
26621400

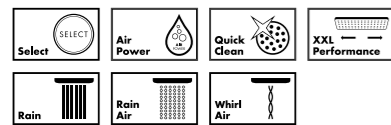

**Raindance Select S**  
120 3jet shower set with 110cm right shower rail  
26326000

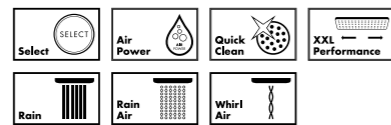

**Raindance Select S**  
120 3jet shower set with 150cm shower rail  
27646000

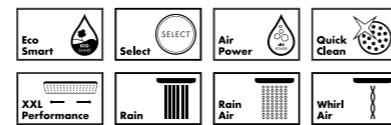

**Crometta**  
100 1jet shower set with 65cm shower rail  
26533400

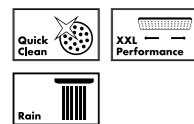

**Croma Select E**  
110 1jet shower system with 90cm shower rail  
26594400

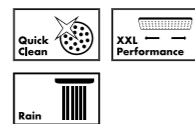

**Croma**  
100 shower set Vario with 90cm shower rail and soap dish  
27771000



# Attractive finishing options, engineered to last

The quality engineering and attention to detail of every hansgrohe product ensures peace of mind from installation to enjoyment. A passion for water and love of innovation means you can trust hansgrohe showering solutions to provide long-term performance and durability. Proven over generations, you will have a truly exceptional experience every time you shower.



## Ceiling mounted overhead showers

Whether you're working with a compact and contemporary space or a large and luxurious one, you'll find a hansgrohe ceiling mounted overhead shower option to fulfil your needs. Modern or classic; square, round or soft cube; every model acts as a stylish focal point in any bathroom.



## Exafill - bath filling without taps

For the bath inflow, waste and overflow, there is the modern hansgrohe alternative to the traditional set-up. The Exafill S unique RainFlow spray fills any bath smoothly and speedily and is never slowed by limescale deposits, thanks to its ingeniously built-in QuickClean technology.

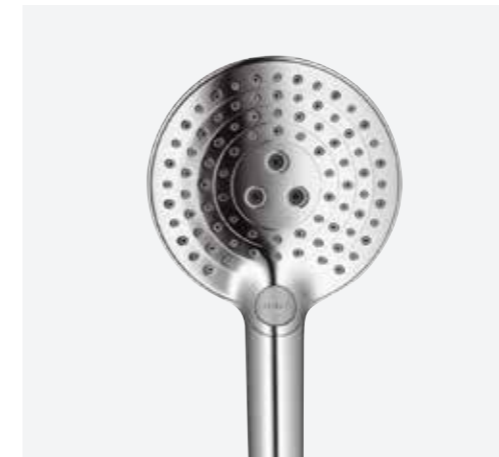

## Chrome finish

Our sophisticated, hansgrohe style is always in fashion, and engineered to stand the test of time.

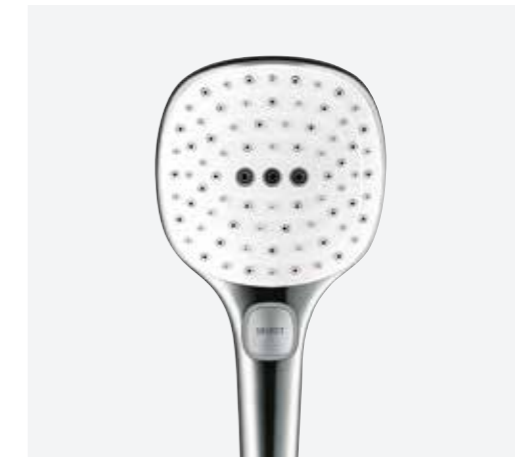

## Chrome and white finish

Our contemporary style that's perfect for hard water areas and made to last.

(Option available at no extra cost)

## The hansgrohe selections

We've now made it easier for you to select your ideal shower, bathroom taps and mixers for washbasins, showers and bathtubs. On the following pages is a selection of stunning solutions that have been specially crafted by hansgrohe. Each one expresses perfectly the combination of function, performance and experience. Please visit your local stockist who will be able to create a solution specifically to suit your home and your needs.

- 32** Concealed valve with overhead shower and slide rail kit
- 36** Concealed valve with overhead shower and hand shower holder
- 40** Concealed valve with slide rail kit
- 44** Concealed valve with overhead shower
- 48** Concealed valve with slide rail kit and Exafill overflow bath filler
- 52** Exposed valve with slide rail kit
- 56** Exposed bath/shower valve with slide rail kit
- 60** Showerpipes: all-in-one shower system





## Concealed valve with overhead shower and slide rail kit

Modernise your bathroom with these versatile shower solutions. Enjoy a relaxing spa-like experience with air-enriched droplets falling from above. Select controls make it easy to switch between hand and overhead shower as well as change between the three spray patterns. Easily set your ideal temperature with the thermostatic control and safety stop.

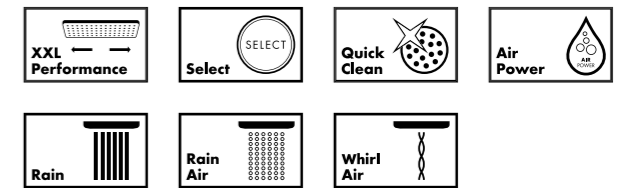

**Square Select valve with Raindance (300) overhead and Select rail kit**

88101005

**£1,803**

Tap into hansgrohe

**Metropol - basin mixers**

See page 66 for full range



# Concealed valve with overhead shower and slide rail kit

Simply select a configuration and design solution that is perfect for you.

All collections include necessary concealed working parts.

**Black glass Select valve with Raindance (300) overhead and Select rail kit.**

88101063

£1,983

Valve available in either black or white glass

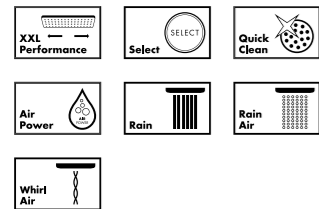

**Square Select valve with Raindance (300) overhead and Select rail kit**

88101005

£1,803

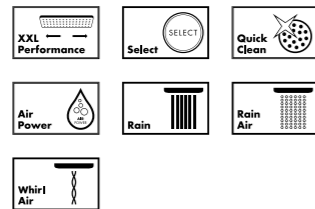

**Round Select valve with Raindance (240) overhead and Select rail kit\***

88101006

£1,698

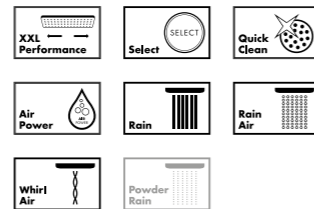

**Square valve with Raindance (300) overhead and Select rail kit**

88101004

£1,638

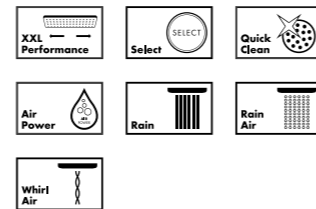

**Round valve with Raindance Select rail kit and Air (240) overhead\***

88101003

£1,508

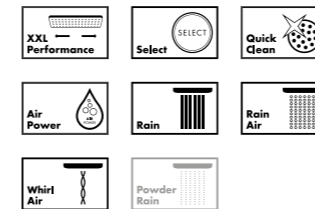

**Soft Cube valve with Raindance Select rail kit and Air (240) overhead**

88101002

£1,473

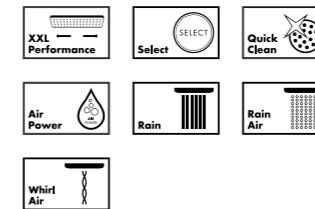

**Soft Cube valve with Cromas Select (180) overhead and rail kit**

88101000

£1,247

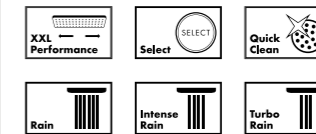

**Round valve with Cromas Select (180) overhead and rail kit**

88101001

£1,247

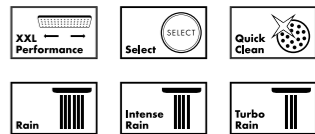

\*PowderRain option is available as either overhead, hand shower or both



## Concealed valve with overhead shower and hand shower holder

A modern bathroom for a lifetime of style and function with EcoSmart and AirPower technology to save water and money. Air-enriched droplets from a generous overhead shower offer a cascade of water. Silicone nozzles simply rub clean of limescale, Select controls ensure ease of use and the thermostat maintains safety and comfort.

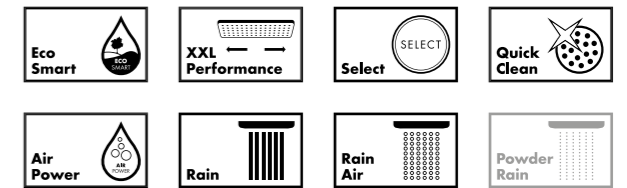

**Round Select valve with Raindance (240) overhead and Baton hand shower\***

88101013

£1,650

Tap into hansgrohe

**Talis E - basin mixers**  
See page 67 for full range



\*PowderRain overhead shower option is available

# Concealed valve with overhead shower and hand shower holder

Simply select a configuration and design solution that is perfect for you.

All collections include necessary concealed working parts.

**Black glass Select valve with Raindance (300) overhead and Baton hand shower**

88101080

£1,940

Valve available in either black or white glass

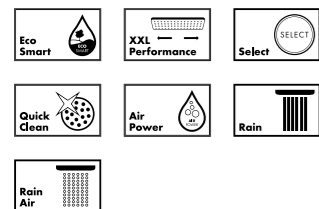

**Square Select valve with Raindance (300) overhead and Baton hand shower**

88101012

£1,760

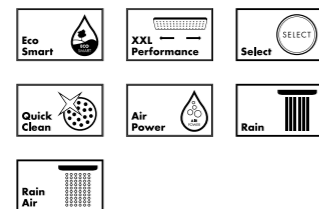

**Round Select valve with Raindance (240) overhead and Baton hand shower\***

88101013

£1,650



**Square valve with Raindance (300) overhead and Baton hand shower**

88101011

£1,595

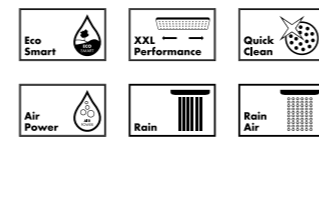

**Round valve with Raindance (240) overhead and Baton hand shower\***

88101010

£1,460

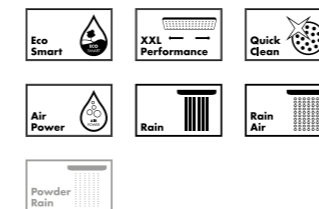

**Soft Cube valve with Raindance (240) overhead and Baton hand shower**

88101009

£1,430

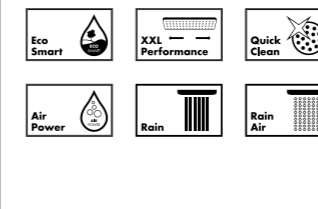

**Round valve with Cromia Select (180) overhead and Baton hand shower**

88101008

£1,290

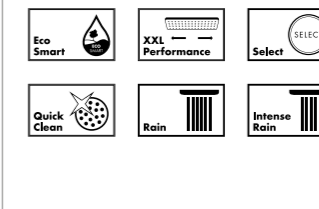

**Soft Cube valve with Cromia Select (180) overhead and Baton hand shower**

88101007

£1,290

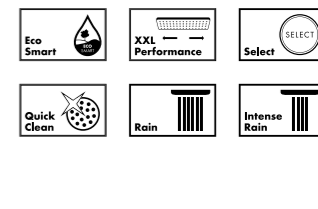

\*PowderRain overhead shower option is available



## Concealed valve with slide rail kit

From soft air-enriched droplets to a strong massage spray perfect for rinsing out shampoo, this is the shower solution to keep everyone happy. Effortlessly switch between the three spray patterns at the touch of a button even with soapy hands. A thermostatic control with safety stop makes it easy to set and maintain your ideal temperature.

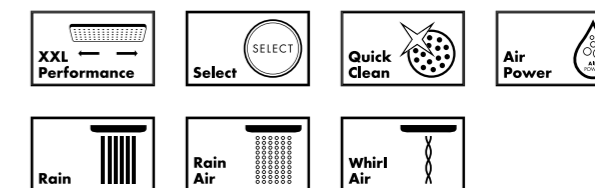

**Square valve with  
Raindance Select rail kit**  
88101018

**£888**

Tap into hansgrohe

**Metris - basin mixers**  
See page 66 for full range



# Concealed valve with slide rail kit

Simply select a configuration and design solution that is perfect for you.

All collections include necessary concealed working parts.

**Black glass Select valve with Raindance Select rail kit**

88101089

£1,213

Valve available in either black or white glass

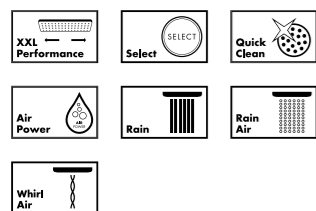

**Round Select valve with Raindance Select rail kit\***

88101020

£1,053

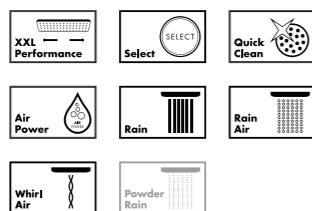

**Square Select valve with Raindance Select rail kit**

88101019

£1,048

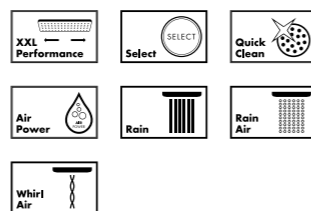

**Square valve with Raindance Select rail kit**

88101018

£888

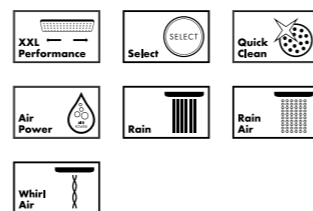

**Round valve with Raindance Select rail kit\***

88101017

£878



**Soft Cube valve with Raindance Select rail kit**

88101016

£873

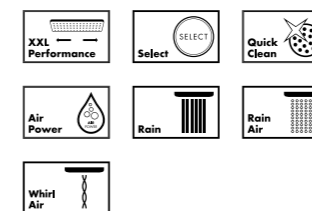

**Round valve with Cromas Select rail kit**

88101015

£787

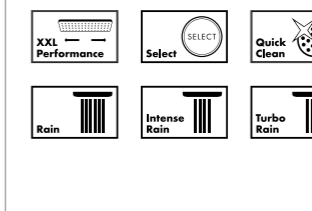

**Soft Cube valve with Cromas Select rail kit**

88101014

£787

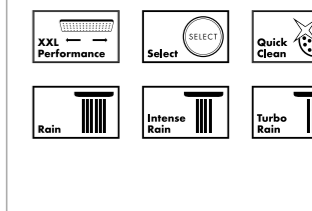

\*PowderRain hand shower option is available



## Concealed valve with overhead shower

Whether you prefer classic or modern, the circular design of this shower pack will ensure you get the shower you deserve. The simple-to-use Select button allows effortless switching between spray patterns whilst silicone nozzles easily rub clean of limescale. Set your ideal temperature and maintain it with the thermostatic control and safety stop.

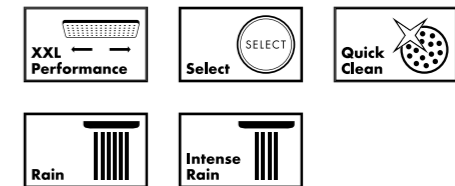

**Round valve with  
Croma Select (180) overhead**  
88101022

**£1,004**

Tap into hansgrohe

**Talis S - basin mixers**  
See page 67 for full range



# Concealed valve with overhead shower

Simply select a configuration and design solution that is perfect for you.

All collections include necessary concealed working parts.

**Black glass Select valve with Raindance (300) overhead**  
88101102  
**£1,624**  
Valve available in either black or white glass



**Square Select valve with Raindance (300) overhead**  
88101026  
**£1,459**



**Round Select valve with Raindance (240) overhead\***  
88101027  
**£1,349**



**Square valve with Raindance (300) overhead**  
88101025  
**£1,299**



**Round valve with Raindance (240) overhead\***  
88101024  
**£1,174**



**Soft Cube valve with Raindance (240) overhead**  
88101023  
**£1,144**

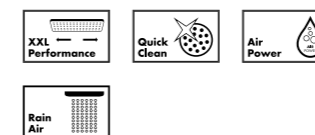

**Soft Cube valve with Cromas Select (180) overhead**  
88101021  
**£1,004**

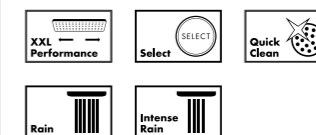

**Round valve with Cromas Select (180) overhead**  
88101022  
**£1,004**

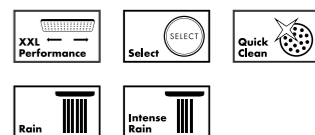

\*PowderRain overhead shower option is available





## Concealed valve with slide rail kit and Exafill overflow bath filler

Switch between bath or shower and adjust the temperature with a simple twist of the handle on one neat control unit. A welcoming bath is speedily but discreetly filled from the wide flood jet whilst the shower offers three different spray patterns that are sure to keep the whole family happy.

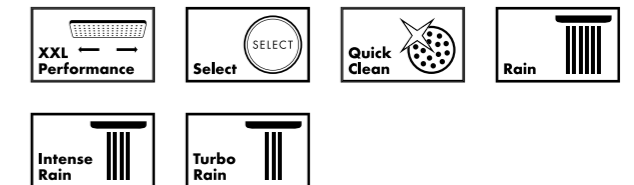

**Soft Cube valve with Cromo Select rail kit and Exafill**  
88101028

**£1,192**

Tap into hansgrohe

**Talis E - basin mixers**  
See page 67 for full range



# Concealed valve with slide rail kit and Exafill overflow bath filler

Simply select a configuration and design solution that is perfect for you.

All collections include necessary concealed working parts.

**Black glass Select valve with Raindance Select rail kit and Exafill**

88101108

£1,648

Valve available in either black or white glass

**Round Select valve with Raindance Select rail kit and Exafill\***

88101034

£1,473

**Square Select valve with Raindance Select rail kit and Exafill**

88101033

£1,468

**Square valve with Raindance Select rail kit and Exafill**

88101032

£1,303

**Round valve with Raindance Select rail kit and Exafill\***

88101031

£1,283

**Soft Cube valve with Raindance Select rail kit and Exafill**

88101030

£1,278

**Round valve with Cromas Select rail kit and Exafill**

88101029

£1,192

**Soft Cube valve with Cromas Select rail kit and Exafill**

88101028

£1,192

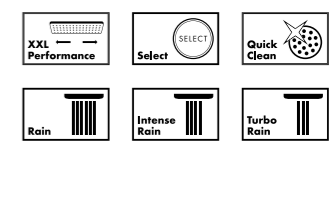
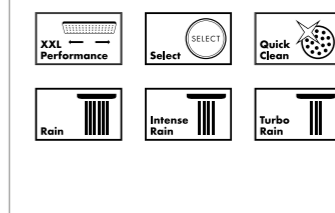
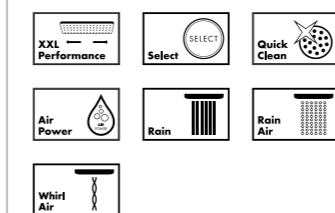
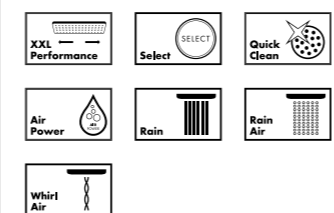
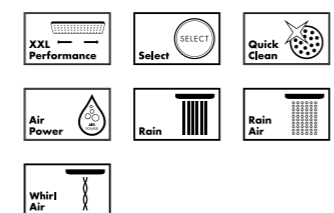
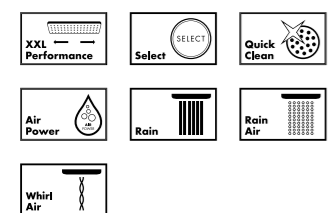

\*PowderRain hand shower option is available



## Exposed valve with slide rail kit

From soft air-enriched droplets to a strong massage spray perfect for rinsing out shampoo, this is the shower solution that keeps the whole family happy. Simply switch between three spray patterns at the touch of a button - even with soapy hands - set and maintain your ideal temperature with its thermostatic control with safety stop.

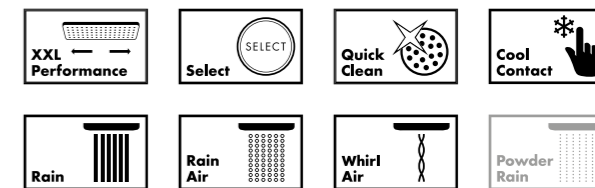

**Round Raindance Select rail kit with Select valve\***  
88101040

**£783**

Tap into hansgrohe

**Focus - basin mixers**  
See page 68 for full range



\*PowderRain hand shower option is available

# Exposed valve with slide rail kit

Simply select a configuration and design solution that is perfect for you.

All collections include necessary concealed working parts.

**Round Raindance Select rail kit with Select valve\***  
88101040  
**£783**

**Soft Cube Raindance Select rail kit with Select valve**  
88101039  
**£735**

**Soft Cube Raindance Select rail kit with Cool Contact Cromia E valve**  
88101121  
**£531**

**NEW**

**Round Raindance Select rail kit with valve\***  
88101038  
**£488**

**Soft Cube Raindance Select rail kit with valve**  
88101037  
**£483**

**Soft Cube Cromia Select rail kit with valve**  
88101035  
**£360**

**Round Cromia Select rail kit with valve**  
88101036  
**£340**

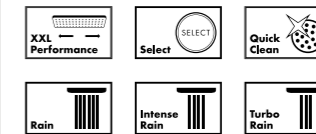
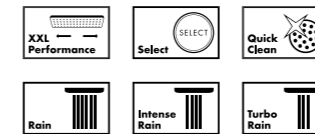
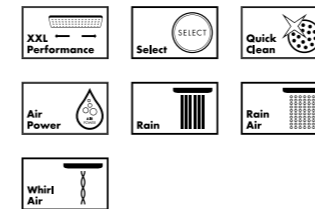
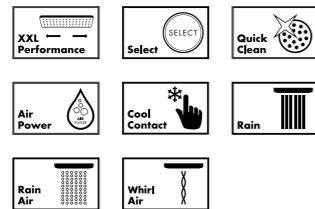
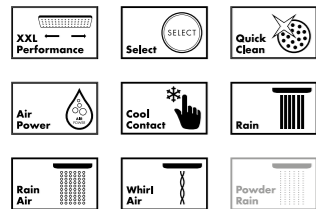

\*PowderRain hand shower option is available



## Exposed bath/shower valve with slide rail kit

Create the perfect all-in-one shower solution with this exposed bath filler with Select technology, partnered with this multi-function hand shower to switch between the three spray patterns. Go from shower to bath at the touch of a button with its large coded symbols, using the handy control dial to choose and set your ideal temperature for both the shower and the bath.

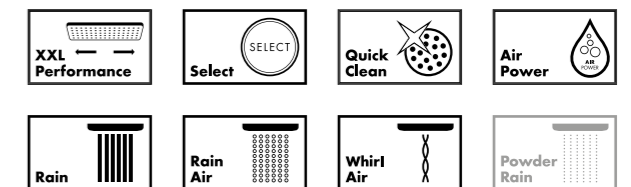

**Round Raindance Select rail kit with Select bath/shower valve\***  
88101044

**£986**

Tap into hansgrohe

**Logis - basin mixers**  
See page 68 for full range



\*PowderRain hand shower option is available

# Exposed bath/shower valve with slide rail kit

Simply select a configuration and design solution that is perfect for you.

All collections include necessary concealed working parts.

**Round Raindance**  
**Select rail kit with Select**  
**bath/shower valve\***  
 88101044  
**£986**

**Soft Cube Raindance**  
**Select rail kit with Select**  
**bath/shower valve**  
 88101043  
**£981**

**Soft Cube Raindance Select**  
**rail kit with Cool Contact**  
**Croma E bath/shower valve**  
 88101122  
**£636**

**NEW**

**Soft Cube Croma**  
**Select rail kit with**  
**bath/shower valve**  
 88101041  
**£515**

**Round Croma**  
**Select rail kit with**  
**bath/shower valve**  
 88101042  
**£515**

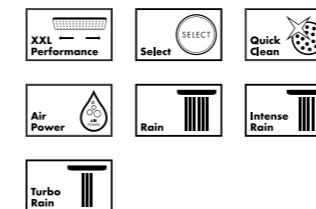
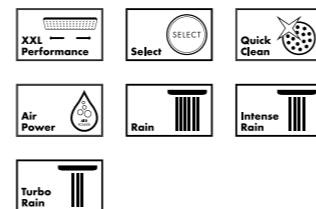
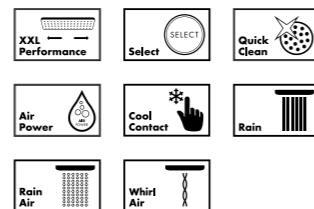
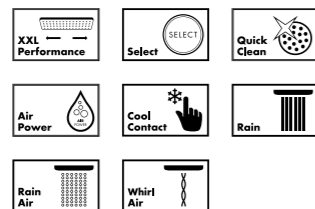

\*PowderRain hand shower option is available





## Showerpipes: all-in-one shower system

This Showerpipe offers a unique showering experience with a large spray plate and generous flow of water to help you really relax. Switch between overhead or multi-function hand shower with a push on the front-facing button with its large coded symbols. With three spray patterns available, it's your perfect all-in-one shower solution.

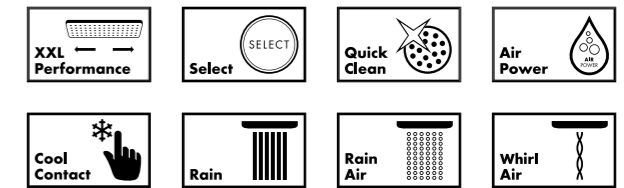

**Soft Cube Raindance  
Select 360 showerpipe**  
88101048

**£1,910**

Tap into hansgrohe

**Metris - basin mixers**  
See page 66 for full range



# Showerpipes: all-in-one shower system

Simply select a configuration and design solution that is perfect for you.

All collections include necessary concealed working parts.

**Soft Cube Rairdance  
Select 360 showerpipe**  
88101048  
**£1,910**

**Square Rairdance 300  
showerpipe**  
88101049  
**£1,750**

**Select PowderRain 240  
showerpipe**  
88101113  
**£1,150**

**Round Croma Select 280  
showerpipe**  
88101046  
**£900**

**Round Rairdance Select 240  
showerpipe**  
88101047  
**£870**

**Croma E Cool Contact  
showerpipe**  
88101123  
**£800**

**NEW**

**Round Croma 220  
Showerpipe**  
88101045  
**£725**

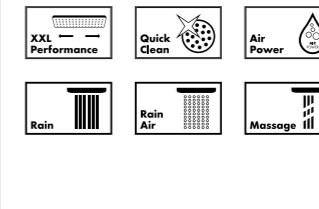
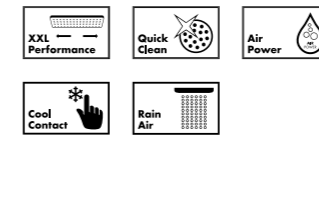
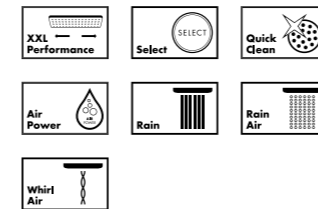
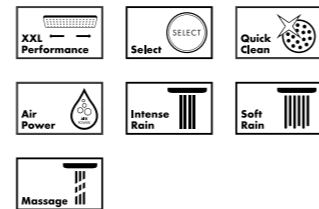
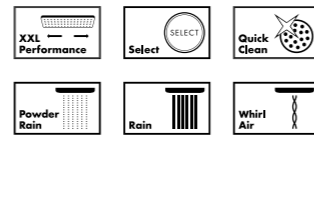
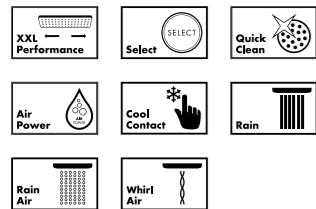





## hansgrohe: style on tap

Whether you prefer understated design, timeless elegance or something a little more unusual, hansgrohe gives you a dramatic diversity of styles. From cool contemporary to classic simplicity, all our taps are designed by the award-winning studio Phoenix Design and fulfil the most stringent requirements in terms of quality and usability. A selection of our taps feature EcoSmart and AirPower technology. EcoSmart will help save your water and money in the long run, whilst the AirPower feature mixes air into the water to make the jet feel pleasantly plump and indulgent.

- 66 Metropol
- 66 Metris
- 67 Talis E
- 67 Talis S
- 68 Focus
- 68 Logis
- 69 Logis Accessories

# Metropol®

If you prefer clean and contemporary design, Metropol will match your aesthetic sensitivities. The upscale taps are ideal for bathroom settings with a geometric design. The Metropol range features various handles and spout options to complement linear shapes and make an impressive design statements in your home.



**Metropol**  
Select basin mixer 110  
with push-open waste  
32571000

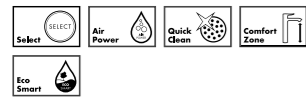

**Metropol**  
Single lever basin mixer 110 with  
lever handle and push-open waste  
32507000



**Metropol**  
Single lever basin mixer 260 with lever  
handle for wash bowls with push-open waste  
32512000



**Metropol**  
3-hole basin mixer 110 with  
lever handle and push-open waste  
32514000



# Metris®

A timeless style to suit any surroundings. Define your bathroom with a range of personal preferences all of which feature our high-quality reliability and gentle curves. Together with the precision edges, it creates a natural look that just won't age.



**Metris**  
Single lever basin mixer 100 for  
cloakroom basins without waste  
31186000



**Metris**  
Single lever basin mixer 200  
without waste  
31185000



**Metris**  
Single lever basin mixer 230  
with push-waste  
31187000



**Metris**  
Single lever basin mixer for concealed  
installation with spout 22.5 cm  
31086000



Please visit [hansgrohe.co.uk](http://hansgrohe.co.uk) for the complete tap collection  
Alternative waste options are available

# Talis® E

Talis E exudes elegance with its gently tapered base set merges into a graceful spout with an opulent surface. Precision edges line the spout and lever allowing the Talis E to simply emanate quality. With the Select option, you can even operate the taps conveniently with a finger, arm or elbow.



**Talis E**  
Select basin mixer 110  
without waste  
71751000

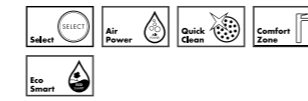

**Talis E**  
Single lever basin mixer 110  
without waste  
71712000



**Talis E**  
Single lever basin mixer 240  
with pop-up waste  
71716000



**Talis E**  
3-hole basin mixer  
with pop-up waste  
71733000



# Talis® S

A naturally unique design. The downward-slanting, conical spout merges with the uniform base set, while the slender pin handle guarantees convenience. Talis S Select basin taps make do without a lever and the Select push button offers you ultimate ease.



**Talis S**  
Select basin mixer 100  
without waste  
72043000

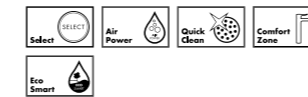

**Talis S**  
Single lever basin mixer 100  
without waste  
72021000



**Talis S**  
Single lever basin mixer 190  
with pop-up waste  
72031000



**Talis S**  
Single lever basin mixer 250  
without waste  
72116000



Please visit [hansgrohe.co.uk](http://hansgrohe.co.uk) for the complete tap collection  
Alternative waste options are available

# Focus<sup>®</sup>

Take joy in your daily moments with water. With the Focus range, the priority is relaxation and convenience at an attractive price. The timeless design with the dynamic shape, gently rounded edges of the spout and ergonomic handle looks just as good as it feels.



**Focus**  
Single lever basin mixer 70  
without waste  
31733000



**Focus**  
Single lever basin mixer 100  
without waste  
31517000



**Focus**  
Single lever basin mixer 230  
without waste  
31532000



**Focus**  
3-hole basin mixer 100  
with pop-up waste  
31937000



# Logis<sup>®</sup>

The high-end look features clear lines and gently curved surfaces; an aesthetic shape that's also functional and easy to maintain. EcoSmart technology will help save your water and money in the long run too. Its AirPower feature mixes air into the water at the same time to make the jet feel pleasantly plump and indulgent.



**Logis**  
Single lever basin mixer 70  
without waste  
71071000



**Logis**  
Single lever basin mixer 100  
without waste  
71101000



**Logis**  
Single lever basin mixer 190  
without waste  
71091000



**Logis**  
Single lever basin mixer 210  
with swivel spout without waste  
71131000



# Logis Accessories

The finishing touches in any modern bathroom.

All accessories include the necessary fixings. All accessories can also be purchased individually.



**Logis Accessories  
bathroom pack**

88100983

Pack consists of:

- Toilet roll holder without cover
- Toilet brush holder wall-mounted
- Towel ring
- Toothbrush tumbler
- Liquid soap dispenser

£192



**Logis Accessories  
cloakroom pack**

88100982

Pack consists of:

- Toilet roll holder without cover
- Toilet brush holder wall-mounted
- Towel ring
- Soap dish

£145

# Peace of mind from installation to enjoyment

The quality engineering and attention to detail of every hansgrohe product ensures absolute ease of installation.

A passion for water and love of innovation means you can trust hansgrohe showering solutions to provide long term performance and durability. Proven over generations, you will have a truly exceptional experience, every time you shower.

## Selecting the right products

To discover which showering products will best deliver the exceptional showering experience you seek, it is important to identify correctly the system that is installed in your home. If you are unsure of the system or the water pressure it provides, please consult your professional installer.

## Understanding your water system

Identifying the water pressure provided by your plumbing system will allow you to choose a showering product designed to work most efficiently within its parameters. Water pressure is the term used to describe the strength of the water flow through a pipe and is measured in bars.

## Installation

Understanding your system's ability to deliver water is essential in order to match your chosen showering solution's performance. A qualified installer will have the knowledge and experience to help you achieve your desired result with the reassurance of exceptional performance in the years ahead.

## Service and maintenance

Every hansgrohe product provides the added reassurance of a 5-year guarantee with the availability of spare parts also guaranteed for 15 years. All products professionally installed are designed to be serviced if necessary in situ.



**Proud sponsor of  
UCI World Tour  
cycling team**

**Peter Sagan**  
UCI World Champion  
2015/2016/2017

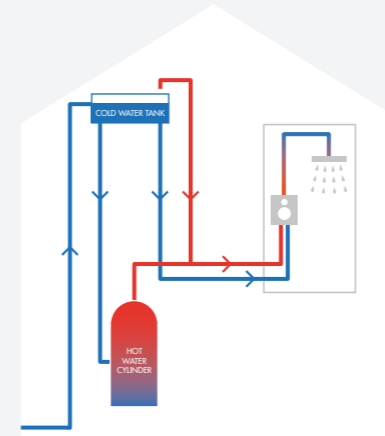

## Gravity

### Low Pressure - LP (0.2Bar)

- Cold water storage tank in the loft
- Hot water cylinder in property
- No shower pump installed

\*All hansgrohe showers in this brochure require a pump if you have this system

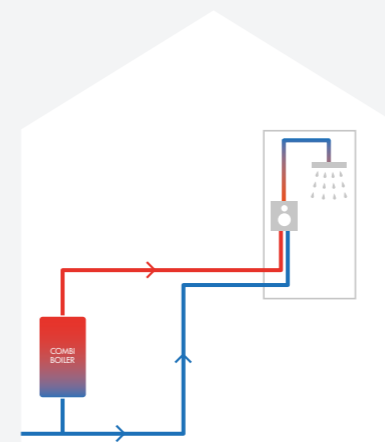

## Combination Boiler

### Medium Pressure - MP (1Bar - 1.5Bar)\*

- Combination boiler fitted providing hot water on demand
- No storage tanks in property
- No shower pump installed

\*Pressure is dependent upon the age and size of the combi boiler plus the mains water pressure. A modern 28KW combi boiler will typically provide between 1Bar - 1.5Bar pressure.

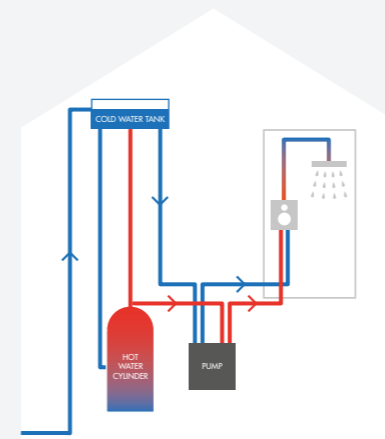

## Pump Assisted

### High Pressure - MP - HP (1.5 - 3Bar Plus)

- Booster pump installed

When the gravity of water exceeds 0.61pm, this is known as 'Positive Head' (ie. when a shower head is positioned below the cold water storage tank). In this situation a standard, or Positive Head, shower pump can be used. Please note, this is with the exception of our Select valves and mixers. These require a Universal pump to be installed.

A 'Negative Head' condition is when the gravity of water is less than 0.61pm (i.e. when a shower head is positioned above the cold water storage tank, e.g. in a loft conversion). In these conditions a universal head pump must be used. Please note, a Universal shower pump will work in both positive and universal head conditions. (i.e. where the shower head is either above or below the cold water storage tank). The correct pump will allow you to use any of the products featured this brochure.

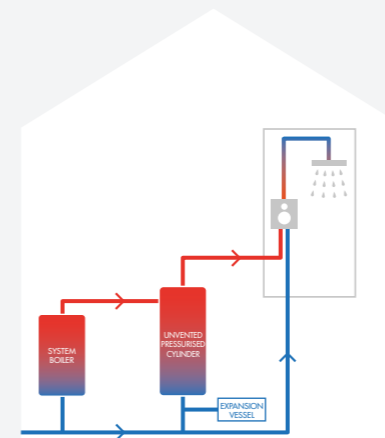

## Mains High Pressure

### High Pressure - HP (1.5 - 3Bar)

- Unvented cylinder with an expansion cylinder
- No cold water storage tank in the loft
- Stored hot water
- Balanced Pressure
- Limited to Mains Pressure

# hansgrohe



## Hansgrohe Customer Service

For technical enquiries, our experts will be happy to assist you with their extensive knowledge of the entire hansgrohe product range. Service and replacement parts are delivered in the fastest possible manner.

Service hours:

Monday - Friday: 9am - 5pm

Trade Helpline: 01372 472077

Enquiries: [customerservices@hansgrohe.co.uk](mailto:customerservices@hansgrohe.co.uk)

Hansgrohe Limited - Units D1 and D2 - Sandown Industrial Park  
Esher - Surrey - KT10 8BL - Telephone 01372 465655

Meet the beauty of water - Subject to technical alterations and colour differences due to the printing process.  
Prices listed are inclusive of VAT. Prices are subject to change and were correct at time of going to print. Form-Nr. 07004362