

ROPER RHODES[®]

BATH



Fitted Furniture 01 | 2019

FITTED FURNITURE

Roper Rhodes has been providing quality products for British bathrooms for almost 40 years.

We invest heavily in developing new ranges that combine good design, functionality and style so you can be sure your Roper Rhodes bathroom is fit for purpose day after day.

We are recognised throughout the industry for our excellent customer service. We carry good stock levels on all our standard ranges so, once you've confirmed your order, you won't have to wait long for delivery. And we're so confident in the quality of our products that they come with a 10 year guarantee against manufacturing defects.



Contents

04

PLAN YOUR BATHROOM

- 04 The Perfect Fit
- 05 Why Choose Us
- 06 Planning Your Bathroom
- 08 Step-by-Step Ordering Guide

10

FITTED FURNITURE RANGES

- 14 Burford Derwent Blue
- 16 Burford Mercury
- 18 Burford Slate Grey
- 20 Burford Pebble Grey
- 22 Burford Chalk White
- 24 Burford Mocha
- 28 Aruba Derwent Blue
- 30 Aruba Gloss Dark Clay
- 32 Aruba Alpine Elm
- 34 Aruba Charcoal Elm
- 36 Aruba Mercury
- 38 Aruba Mocha
- 40 Aruba Flintwood
- 42 Aruba Natural Oak
- 44 Aruba Washed Oak
- 46 Aruba White
- 50 Vetro Light Grey
- 52 Vetro White
- 54 Vetro Cinder
- 58 Capella White

60

SANITARYWARE

- 63 Accent
- 64 Cover
- 65 Harrow
- 66 Note
- 67 Zest
- 68 Minerva
- 69 Geo
- 70 Flushing Options
- 71 Wall Hung Frames & Cisterns



Let's Get Social
facebook.com/roperrhodes
twitter.com/roperrhodesltd
youtube.com/roperrhodes
pinterest.com/roperrhodes
instagram.com/roperrhodes

76

FINISHING TOUCHES

- 78 Worktop Options
- 79 Strata Solid Surface Worktops
- 80 Basins With Integrated Worktops
- 82 Soft Touch Laminate Worktops
- 83 Laminate Worktops
- 84 Handles
- 86 Taps
- 88 Lighting Options

90

PRICING & TECHNICAL INFORMATION

- 92 Standard Depth Units
- 96 Standard Depth Shelving Units
- 99 Slim Depth Units
- 103 Slim Depth Shelving Units
- 105 Wall Cupboards
- 107 Handles
- 108 Worktops
- 111 Panels & Plinths
- 113 Bath Panels
- 114 Cabinets
- 114 Mirrors
- 115 Lighting
- 116 Sanitaryware
- 124 Taps
- 127 Planning Tips & Advice
- 130 Terms & Conditions

All prices are inclusive of VAT at 20%

Technical Information

Further technical information on all products, including fitting instructions, aftercare documents and detailed dimensions can be found by visiting the Roper Rhodes website. roperrhodes.co.uk

THE PERFECT FIT

Whatever your bathroom space, big or small, our fitted furniture offers the flexibility and versatility you need to create the perfect fit.

Fitted furniture helps create a unified bathroom look as well as maximise your bathroom's available space, but with our stunning collection it needn't be frumpy. Fresh, contemporary finishes, coordinating worktops and thoughtful finishing touches abound.



WHY CHOOSE US?

Offering quality, excellent service and availability are our prime objectives.

We are always seeking to improve our existing high level of customer service and constantly monitor the way our staff fulfil this objective. We offer simplicity in the ordering and pricing of our ranges to make this as easy for you as possible.

We carry good stock levels of our standard items to provide excellent availability of product to our customers. This means that when you order a fitted bathroom from us you can expect to receive your bathroom furniture within three working days.



HEATED DEMISTER PAD
Make steamy mirrors a thing of the past. The pad will heat the mirror within 2-3 minutes, preventing it from misting

10 YEAR GUARANTEE
All fitted furniture units come with a 10 year guarantee against manufacturing defects

COORDINATE YOUR LOOK
A natural oak worktop matches the internal carcass recommended for use with most of the Burford range

SOFT CLOSE
A quieter life is guaranteed with the added luxury of soft close doors and drawers

PLANNING YOUR BATHROOM

At Roper Rhodes we want to make your life easier. There are a few key elements you should consider when planning your new bathroom.



With our fitted furniture it is easy for you to design and plan your new bathroom. What's more we have simplified the ordering procedure into a series of basic steps for you to follow, see pages 8-9.

What look do you want to create?

A range of styles can be created from one unit, whether it is wall hung for a more modern, European feel, or used with the supplied plinths to create a fully fitted wall-to-wall effect.

Please remember that the photography shown in this brochure is only an example of what can be done.

Decide on the finish and colours

Lighter colours such as high gloss white, chalk white and alpine elm finishes are particularly effective in smaller bathrooms. Colours such as natural oak or mercury can be used to create homely effects. Painted finishes are very on-trend. Don't forget you can order a

different colour carcass to door finish, creating an individual look. There is a choice of 4, including white, silver, graphite and natural oak.

FITTED FURNITURE PRODUCT DETAILS

Slim depth units

All slim depth units are 820mm(h) x 218mm(d) with the exception of the full height unit which is 1900mm(h)

Back to wall WC units	Basin units with 2 doors	Floor units	Toilet Roll Holder	Shelf Unit	Full height 2 doors
500mm 600mm	500mm 600mm 700mm	200mm 300mm 400mm	200mm	300mm	300mm

Standard depth units

All standard depth units are 820mm(h) x 353mm(d) with the exception of the full height unit which is 1900mm(h)

Back to wall WC units	Basin units with 2 doors	Floor units	Toilet Roll Holder	Twin drawer	Triple drawer	Shelf unit	Full height 2 doors
500mm 600mm	500mm 600mm 700mm	200mm 300mm 400mm	600mm 200mm	300mm	300mm	300mm	300mm

Mirrors & wall cabinets are suitable for use with standard & slimline depth units. All items are 640mm(h) and cabinets are 218mm(d)

Wall mounted cabinets				Mirrored cabinets			
200mm	300mm	400mm	600mm	300mm	500mm	600mm	700mm
Mirrors							
500mm	600mm*	700mm*	Air 560mm*				

* Heated mirror pad supplied with mirror

Which worktops?

There are so many finishes to choose from. Premium matt, soft touch laminate worktops are superbly tactile while our gloss finish black granite and white laminate worktops will sparkle under LED lighting.

Using Strata solid surface worktops will add a more contemporary and luxurious look and feel.

The layout of your bathroom

Get a feel for your bathroom layout before you start. Look at any wasted areas which could be maximised with the addition of storage units. It is advisable to install a WC unit in a similar position to the current WC to minimise installation costs.

If you do want to change the layout of your bathroom, a good bathroom retailer will be able to guide you through the planning process.

Installation

As with any new bathroom furniture, it is advisable to use an experienced and qualified installer. Many Roper Rhodes retailers will be able to offer a design and installation service or will be able to recommend suitable fitters and tradesmen.

Use the item guide above to populate your new bathroom layout.

STEP-BY-STEP ORDERING GUIDE

1. Door finishes

The most important choice when determining the look of your bathroom is door finish. Luckily we have many fabulous finishes for you to select from, covering all bases from on-trend painted finishes to natural wood looks. See pages 12-59 for inspiration.

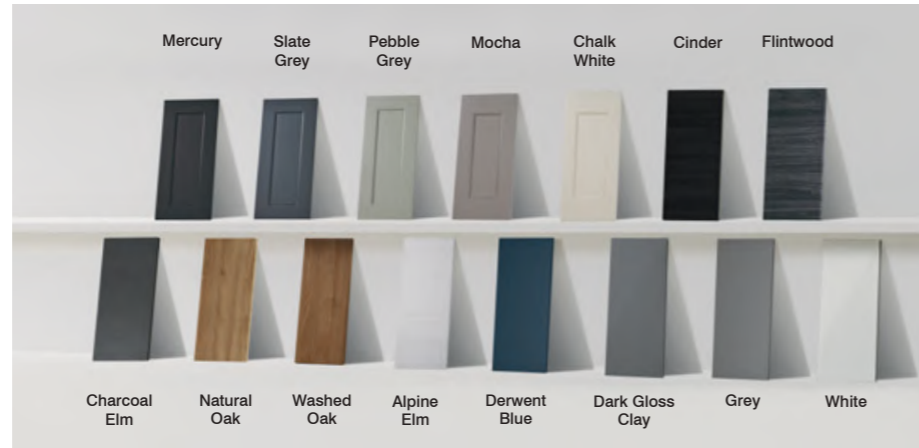

2. Door/fascia style

Door style will also influence your overall design. Choose from the classic shaker styles of Burford to the ultra-modern simplicity of Aruba slab style doors.

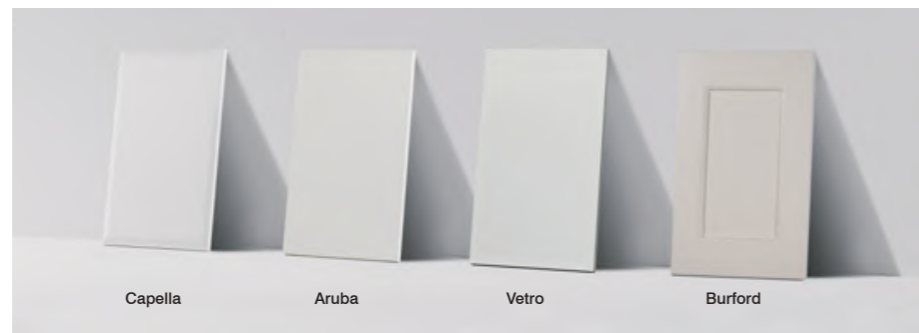

3. Carcass finish

Now select your internal carcass finish. The recommended carcass colour to be used with each door finish for best effect is detailed on pages 92-106, but you can choose to order whichever carcass colour you wish to achieve your desired look.

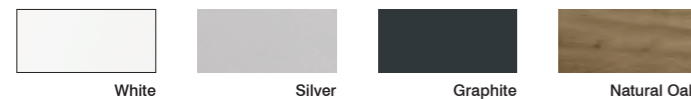

4. Combination & depth of units

Assess the space you have available in your bathroom and choose from standard depth (353mm) or space-saving slim depth (218mm) units. Then consider which combination of units which will work for you to maximise the space in your bathroom.

5. Handle options

Add the perfect finishing touch to your chosen doors with one of our range of handles. See page 84 for the full list of all available options.

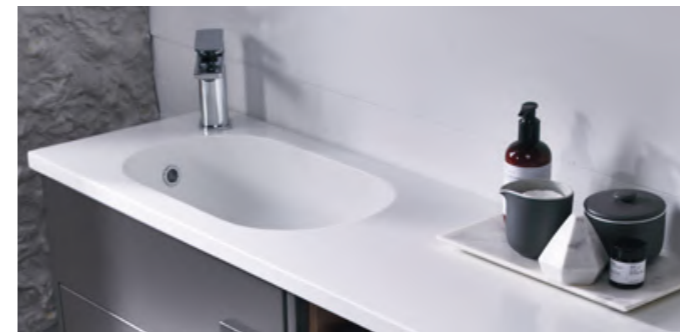

6. Worktop options

Select a worktop from either our Strata solid surface or laminate options. Alternatively opt for either the solid surface City underslung basin or motif semi-recessed basin. Both have an integrated worktops for a seamless look which works equally well with both contemporary and classic bathroom designs. See pages 78-83 for further details.



Don't forget your end panels
Colour matched to complete your furniture

7. Sanitaryware options

Choose your preferred sanitaryware to match the styling of your bathroom. See pages 62-75 for options.

8. Panels & plinths

Coordinating clad-on end panels or thicker accent panels are available in all door finishes. These are optional when choosing a range with a colour matched carcass. If you select a range with a contrasting coloured carcass you will need to use end panels to cover the exposed unit sides. They can also be used between units to achieve a framed effect. See pages 111-112.



9. Mirror & wall cupboard options

Choose your preferred mirror, and maybe also add some useful wall cupboards for extra storage. See pages 114-115.

10. Lighting options

Choose your preferred lighting. See page 115 for options.



11. Bath panel options

Choose your bath panel to keep everything coordinated. See page 113 for options.

12. Tap options

Top your basin with one of our stylish basin mixers. See page 86-87 for options.



PETER LINDSELL
Product Designer

Whatever your bathroom space, big or small, our fitted furniture offers the flexibility & versatility you need to create a unified bathroom look. Our range has something for every taste & the designs incorporate a host of thoughtful features, functionality & style.

Fitted Furniture



BURFORD

*Elements of traditional carpentry
with the advantages of fitted furniture
in a choice of 6 painted finishes*

BURFORD DERWENT BLUE

Strike the perfect balance between modern and traditional with stunning Derwent blue; full of character and depth, it combines tailored lines with a touch of classic styling.

Complete this traditional style with a double basin, ideal for those wishing to make a real design statement. Opt for the Wessex taps and Washington door handles to complete this look and create a beautiful balance between classic styling & dramatic good looks.

10 year guarantee.



HARROW
Semi-countertop
basin
£181.50

**300MM TRIPLE
DRAWER UNIT**
Featuring three
soft close
drawers
£584.10

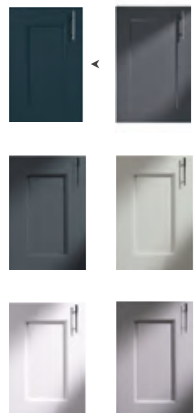

BURFORD MERCURY

*A touch of colour can completely transform your bathroom.
Breathe new life into your space with these soothing yet intense mercury grey units in Burford's classic design.*

Burford's simple styling has framed doors, plinths with rails and tongue and groove feature panels. The strong lines this creates are particularly complemented by Harrow sanitaryware.

Keep your colour scheme coordinated by choosing to use graphite grey carcasses with your mercury doors.

10 year guarantee.

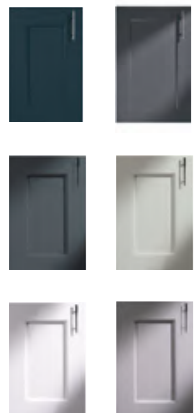

600MM MIRROR
Featuring a heated demister pad
£257.00



COLUMBUS
Chrome handle
£19.00 each

HARROW
Semi-countertop basin
£181.50

CARRARA STRATA WORKTOP
A marble-like solid surface worktop from £186.00



BURFORD SLATE GREY

Create real drama with this deep slate grey finish. A nod to heritage styling, this finish will give your bathroom a sophisticated yet modern feel.

Opt for a Geo basin and Strata worktop or keep everything sleek and seamless by choosing the City underslung basin with integrated solid surface worktop. Using two full height twin door cupboards together will give you masses of valuable storage space.

10 year guarantee.

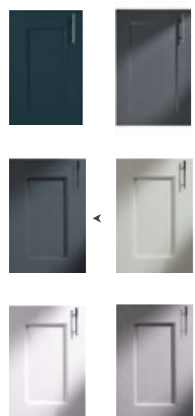

CITY BASIN
Solid surface underslung basin with integrated worktop £610.00

NOTE WC
Back to wall WC and soft close seat
£468.60

BURFORD PEBBLE GREY

For a new take on a classic look opt for the muted tones of pebble grey finish, creating a relaxed & calming environment.

Open shelving and sleek mirrors, used together here with the smooth arctic white Strata solid surface worktop, help create this timeless look.

Use 30mm end panels between the units to create a more traditional framed look. For economy these end panels can be cut in half for use within a run if desired.

10 year guarantee.



NATURAL OAK SHELF STORAGE UNIT
300mm Standard depth shelf storage unit
£146.00 each

GEO BASIN
515mm semi-countertop basin
£181.50 each



END PANELS
Use 30mm end panels between the units to create a traditional framed look. For economy these can be cut in half for use either side of a unit in a run if desired.

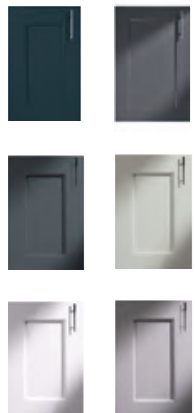

BURFORD CHALK WHITE

In a soft white, Burford has a classic look with framed doors.

Recommended for use with natural oak finish carcass units, a coordinating oak finish worktop is also available.

Use 30mm end panels between the units to create a more traditional framed look and finish with Washington chrome handles.

10 year guarantee.

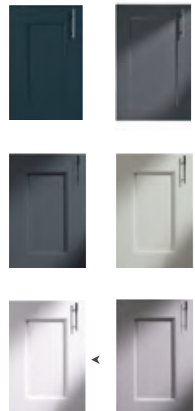

WESSEX BASIN MIXER
Basin mixer with click waste
£202.00

GEO BASIN
515mm semi-countertop basin
£181.50

NATURAL OAK LAMINATE WORKTOP
A wood effect laminate worktop from £107.00 (standard depth)

END PANELS
Use 30mm end panels between the units to create a traditional framed look. For economy these can be cut in half for use either side of a unit in a run if desired.

BURFORD MOCHA

The muted tone of Burford mocha adds to its timeless appeal and really suits the classic styling.

The use of open shelving can be especially effective, breaking up a run and keeping the look classic. Recommended for use with natural oak finish carcass units.

10 year guarantee.

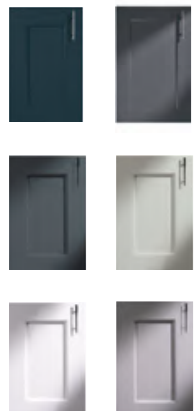

GEO BASIN
515mm semi-countertop basin
£181.50 each

HENLEY BASIN MIXER
Basin mixer with pop up waste
£149.00 each

GEO WC
Back to wall WC & seat
£287.90



ARUBA

*A simple ultra modern style
for effortless cool in a multitude
of on-trend finishes*

ARUBA DERWENT BLUE

Dive in at the dark deep end and inject a splash of colour into your bathroom with this sleek flat door style in rich Derwent blue. Full of warmth and character it's sure to make the right statement. This fabulous hue offers a sophisticated look that is sure to enrich your bathroom design.

Why not elevate your bathroom space and opt for the Motif solid surface basin with integrated worktop. We've selected the Stockton brass handle and brass Elate tap for a real design statement to keep your bathroom right on trend.

10 year guarantee.



MOTIF BASIN & WORKTOP
Solid surface basin with integrated worktop
£674.00



NOTE
Back to wall WC and seat
£468.60

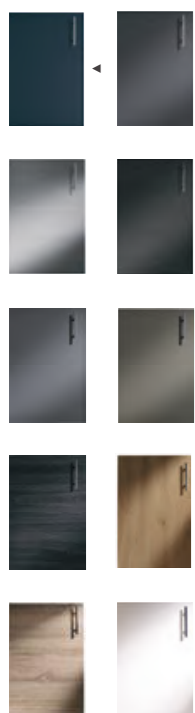

ARUBA GLOSS DARK CLAY

Step things up & bring in an element of luxe to enrich your bathroom design with this glossy dark clay finish. Perfect for creating depth & making a statement.

Keep everything sleek and seamless by choosing the City underslung basin with integrated solid surface worktop. The very practical 3 drawer unit is perfect for all your smaller bathroom items and will keep clutter at bay.

10 year guarantee.

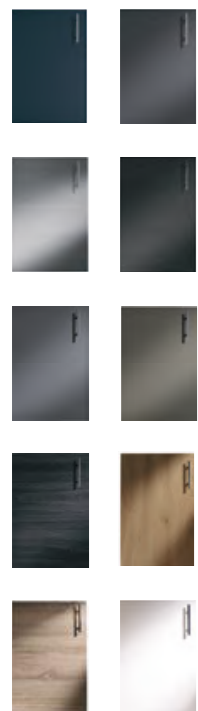

CITY BASIN & WORKTOP
Solid surface under slung basin with integrated worktop
£610.00

300MM TRIPLE DRAWER UNIT
Featuring three soft close drawers
£584.10

ZEST
Back to wall WC and seat
£424.00

ARUBA ALPINE ELM

Cool & light, this contemporary textured finish uses elements from Scandinavian design to create this on-trend stylish look.

The contemporary styling of Aruba works beautifully when contrasted with our matt dark grey, soft touch premium laminate worktop and matt black handles.

Coordinating bath panels are available to complete the room.

10 year guarantee.

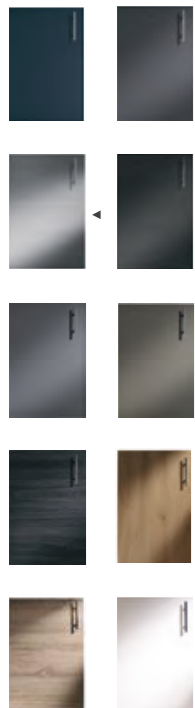

AIM BASIN MIXER

Basin mixer with click waste
£118.50

GEO BASIN

500mm semi-countertop basin
£167.50

SOFT TOUCH LAMINATE WORKTOP

A soft touch, super matt finish laminate worktop from £144.50 (Shale finish shown, standard depth)

A 500mm semi-countertop unit used with a 500mm back to wall unit creates a space-efficient 1m run

ARUBA CHARCOAL ELM

Inject drama & excitement with this contemporary darker textured finish in a fully fitted run.

Contrast charcoal elm with an arctic white solid surface worktop and chrome door top handles. Accent sanitaryware is the perfect choice to complete this look.

10 year guarantee.

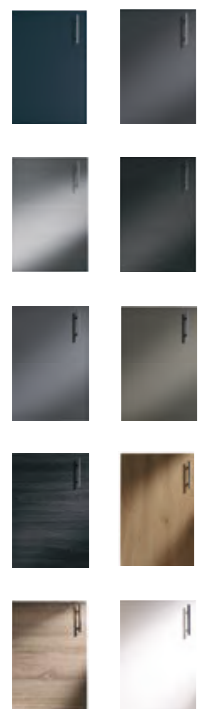

ACCENT BASIN
Slim depth semi-countertop basin
£253.00

AIM BASIN MIXER
Basin mixer with click waste
£118.50

ACCENT WC
Back to wall WC
and seat
£419.60

ARUBA MERCURY

This is sure to become a timeless classic. Aruba slab doors in deep, semi-matt mercury grey add warmth & drama.

Team with the carrara marble Strata solid surface worktop. Why not opt for some contrasting gloss white wall cabinets for an altogether more striking look.

Keep the internals coordinated by choosing graphite grey carcasses for your units.

10 year guarantee.



CARRARA STRATA WORKTOP
A marble-like solid surface worktop from £186.00 (standard depth)

COVER BASIN
Semi-countertop basin £204.50

400MM WALL MOUNTED CUPBOARD
Available in 8 different finishes (white finish shown) £265.30 each

ARUBA MOCHA

This warm muted tone is perfect for a modern bathroom, especially with its semi-matt finish.

The contemporary styling of Aruba works beautifully when teamed with the sleek carrara Strata solid surface worktop and matt black handles. Cover sanitaryware is the perfect choice to complete this look.

10 year guarantee.

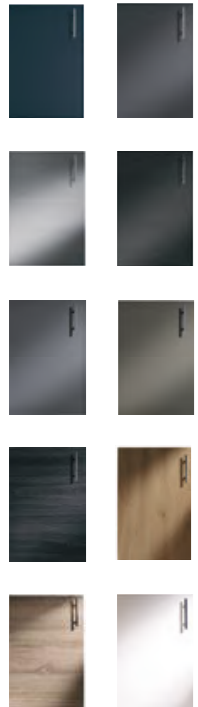

MASSA MARBLE LAMINATE WORKTOP
A marble-like laminate worktop from £90.10 (slim depth)

CODE BASIN MIXER
Basin mixer with click waste
£148.50

COVER WC
Back to wall WC and seat
£419.60

STOCKTON HANDLE
Black finish
from £14.90

ARUBA FLINTWOOD

This cool grey wood grain has a natural texture & packs a punch, offering a dramatic look for the bathroom.

Keep the style contemporary with matt black handles, carrara marble Strata solid surface worktop and Cover sanitaryware.

10 year guarantee.

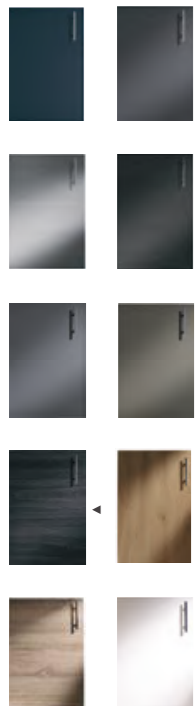

CARRARA STRATA WORKTOP

A marble-like solid surface worktop from £186.00 (standard depth)

SYNC BASIN MIXER

Basin mixer with click waste £148.50 each

COVER WC

Back to wall WC and seat £419.60

ARUBA NATURAL OAK

A warm mid-tone wood finish, smooth to the touch.

We recommend the use of matching oak carcasses with this door finish, to keep everything coordinated.

10 year guarantee.

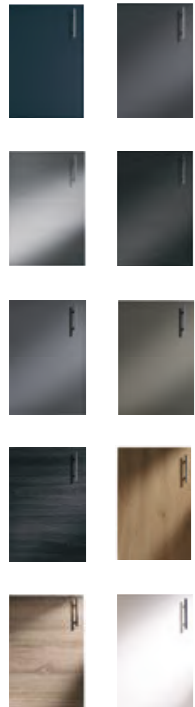

600MM SLIMLINE DOUBLE DOOR CABINETS
Featuring handleless push-open doors and two glass shelves
£428.00 each

GEO BASIN
515mm semi-countertop basin
£181.50 each

ICE WHITE STRATA WORKTOP
A granite-like solid surface worktop from £186.00 (standard depth)

STREAM BASIN MIXER
Basin mixer with click waste
£160.00 each

ARUBA WASHED OAK

A textured mid-tone wood finish, bringing a natural feel to your bathroom.

We recommend the use of silver carcasses with this door finish.

10 year guarantee.

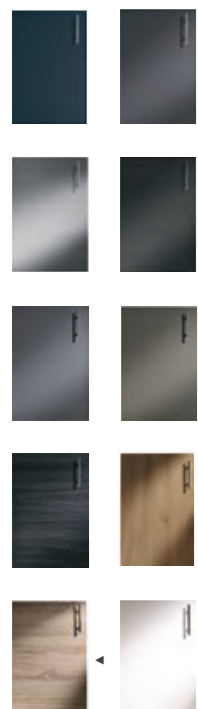

AIR 560MM BACKLIT MIRROR
Featuring a heated demister pad, infrared no touch on/off switch and recharging socket
£337.00

GEO BASIN
515mm semi-countertop basin
£181.50

ISADORA STONE LAMINATE WORKTOP
A stone effect laminate worktop from £107.00 (standard depth)

ELATE BASIN MIXER
Basin mixer with click waste £178.50

GEO WC
Back to wall WC and seat
£287.90

ARUBA WHITE

A crisp gloss painted white finish for ultimate simplicity of style.

Team with contrasting grey slate Strata solid surface worktop and a long chrome handle to complete the look.

10 year guarantee.

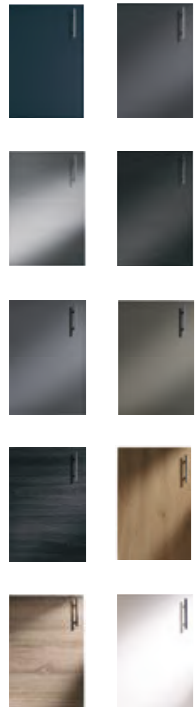

300MM TWIN DOOR CUPBOARD
Featuring adjustable soft close doors
£506.00

GREY MARBLE WORKTOP
A marble-like laminate worktop
from £107.00
(standard depth)

NOTE BASIN
Semi-countertop basin
£284.00



VETRO

Ultra glossy doors for a sharp contemporary edge in 3 finishes

VETRO LIGHT GREY

Ultra glossy slab doors in an on-trend light grey, with a two-tone silver edge creating the illusion of a glass-faced finish.

Go for a really contemporary installation by wall mounting all your units instead of using plinths and leg sets. Door-top handles keep it all minimal. Recommended for use with silver carcass units.

10 year guarantee.



HYDRA BASIN MIXER
Basin mixer with click waste
£157.00

NOTE BASIN
Semi-countertop basin
£284.00

GREY QUARTZ STRATA WORKTOP
A quartz-like solid surface worktop
from £186.00
(standard depth)

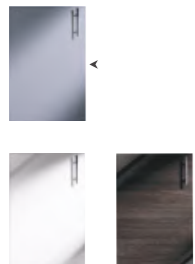

VETRO WHITE

Ultra glossy slab doors in bright white, with a two-tone silver edge creating the illusion of a glass-faced finish.

Opt for the sleek City underslung basin with solid surface worktop to complete the look. We recommend the use of silver carcasses with this door finish.

10 year guarantee.

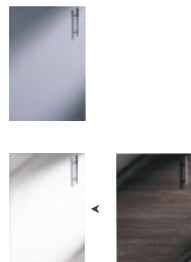

CITY BASIN & WORKTOP
Solid surface under slung basin with integrated worktop
£610.00

NOTE WC
Back to wall WC and soft close seat
£468.60

VETRO CINDER

Ultra glossy slab doors in dark cinder, with a two-tone silver edge creating the illusion of a glass-faced finish.

We recommend the use of graphite grey carcasses with this door finish.

10 year guarantee.

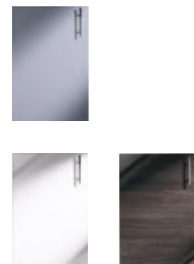

AIR 560MM BACKLIT MIRROR
Featuring a heated demister pad, infrared no touch on/off switch and recharging socket
£337.00



HYDRA BASIN MIXER
Basin mixer with click waste
£157.00



WHITE LAMINATE WORKTOP
Gloss white effect laminate worktop from £107.00 (standard depth)



GEO WC
Back to wall WC and seat
£287.90





CAPELLA

*Subtle curved edges on the doors
give Capella broad appeal.
Available in gloss white*

CAPELLA WHITE

Gently curved doors with a bright gloss white painted finish.

Team with the Alaska handle for great effect and use the white carcass finish.

10 year guarantee.



MINERVA BASIN
Semi-countertop basin
£142.00

SYNC BASIN MIXER
Basin mixer with
click waste
£148.50

PORTLAND STONE LAMINATE WORKTOP
A stone effect laminate
worktop from £107.00
(standard depth)





ROB SHEAN
Product Designer

Whatever style you choose, we have a number of sanitaryware ranges designed to coordinate beautifully. Manufactured using only the finest materials, our carefully selected ranges have true designer appeal & complete the look.

Sanitaryware

ACCENT

The soft modern design of Accent is the perfect companion for our contemporary ranges. Available in both standard & slim depth, the semi-countertop basins offer a deep, practical area space with a space-saving option if required.



560mm standard depth semi-countertop basin
£268.00



550mm slim depth semi-countertop basin
£253.00



510mm back to wall WC & soft close seat
£419.60



505mm wall hung WC & soft close seat
£419.60



630mm close coupled fully enclosed WC & seat
£617.60

COVER

This sanitaryware range with its smooth curved design & thin edges offers generous washing space even on the slim depth semi-countertop option. A choice of three WC options includes a very stylish back to wall version, the perfect choice for fitted furniture, or why not opt for the wall hung or close coupled for a more stand-alone look.



560mm semi-countertop basin
£204.50

560mm slim depth semi-countertop basin
£193.00

530mm back to wall WC & seat
£419.60

525mm wall hung WC & soft close seat
£419.60

660mm close coupled fully enclosed WC & soft close seat
£583.60

HARROW

This collection has more than a nod to the past, being both classically styled & elegant. It looks great with our Burford range for a true period feel. With generous proportions, the basin is available with one or two tap holes & coordinates perfectly with the back to wall WC pan.



550mm ceramic basin 1 tap hole
£181.50

550mm ceramic basin 2 tap hole
£181.50

520mm back to wall WC & soft close wooden seat
£339.50

NOTE

The Note semi-countertop basins look great when teamed with our fitted furniture, with the slim depth option being especially space efficient. The short projection WCs have soft close, quick release seats.



560mm standard depth semi-countertop basin
£284.00



540mm slim depth semi-countertop basin
£269.00



500mm back to wall WC & slim soft close seat
£495.00



500mm wall hung WC & slim soft close seat
£495.00



620mm fully enclosed close coupled WC & soft close seat
£756.60



620mm close coupled WC & soft close seat
£710.60

ZEST

Zest is a comprehensive range, with slim edges & elegant shapes. Four WC options include a very stylish close coupled design & a unique 450mm short projection back to wall version.



500mm standard depth semi-countertop basin
£272.00



435mm slim depth semi-countertop basin
£239.50



450mm back to wall WC & soft close seat
£424.00



500mm back to wall WC & soft close seat
£444.00



500mm wall hung WC & soft close seat
£474.00



655mm close coupled fully enclosed WC & soft close seat
£753.00

MINERVA

Minerva combines simple good looks with practicality. The semi-countertop basin comes in three useful sizes. The WCs work well with your choice of soft close, quick release Juno or Minerva seats and include a comfort height back to wall option.



560mm standard semi-countertop basin
£142.00



540mm slim depth semi-countertop basin
£124.50



460mm slim depth semi-countertop basin
£124.50



515mm back to wall WC & soft close Minerva seat
£226.70



530mm comfort height back to wall WC & soft close Minerva seat
£263.20



660mm close coupled WC & soft close Juno seat
£384.10



660mm close coupled WC & Minerva soft close toilet seat
£400.70

GEO

The soft squares of the Geo range looks great with most ranges. The slim depth semi-countertop basin saves precious space but still has a deep, practical wash space.



500mm standard depth semi-countertop basin
£167.50



515mm standard depth semi-countertop basin
£181.50



540mm slim depth semi-countertop basin
£167.50



505mm back to wall WC & soft close seat
£287.90



655mm close coupled fully enclosed WC & soft close toilet seat
£468.90



655mm close coupled WC & soft close toilet seat
£442.40

FLUSH PLATES

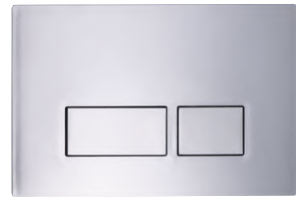

Plaza dual flush push plate

210(w) x 137mm(h)

Chrome TR9010 **£36.20**

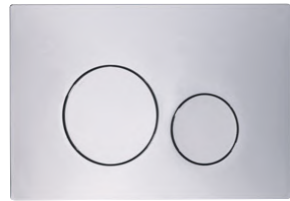

Rondo dual flush push plate

210(w) x 137mm(h)

Chrome TR9012 **£36.20**



Traditional flush push plate

210(w) x 137mm(h)

Chrome TR9017 **£41.80**



Square dual flush button

72(w) x 72mm(h)

Chrome TR9003 **£11.10**



Plaza dual flush push plate

210(w) x 137mm(h)

White TR9011 **£27.70**

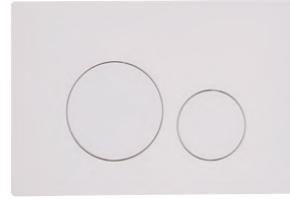

Rondo dual flush push plate

210(w) x 137mm(h)

White TR9013 **£27.70**



Ellipse dual flush push plate

210(w) x 142mm(h)

Chrome TR9004 **£36.20**

Whether you need a contemporary or traditional look, we have flush plates to suit. Compatible for use with our wall hung frames or as an optional upgrade for cisterns.

SENSOR FLUSHING

Touch Sensor Dual Flush Plate



210(w) x 137mm(h)

Black TR9016 **£129.00**

Go for an ultra-contemporary option with our sleek, black glass-fronted touch sensor dual flush plate. The lightest touch on the plate is all that is required to initiate the flush, and the plate lights up to indicate activation.

The sensor plate is best for use on Roper Rhodes wall hung WC frames or the in-wall concealed cistern, and requires 4 AA batteries which will last around a year under normal domestic conditions. The plate allows easy access to change the batteries when required and has a manual override.



Contactless Dual Flush Sensor



Use with concealed cisterns

Sensor kit TR9014 **£107.50**

The contactless flush sensor kit is compatible with pneumatic concealed cisterns from Roper Rhodes, and is best used within furniture. It provides a touchless flush, with just a wave of a hand.

The Sensor works using capacitive sensor technology to detect a change in the electromagnetic field. A short wave of the hand in front of the sensor activates the reduced flush, whilst holding your hand up slightly longer triggers a full flush. It is powered by 4 AA batteries which will last around a year under normal domestic conditions.

The sensor can be mounted behind a back to wall WC unit fascia, or under a worktop or tiled wall near the cistern. A discreet black decal is included to indicate sensor location if desired.



WALL HUNG FRAMES & CONCEALED CISTERNS

1.17m wall hung WC frame



6/3 litres
500(w) x 1168(h) x 140 - 200mm(d)

1.17m frame TR9006 **£234.50**

Use for in-wall applications, includes fittings, requires flush plate/button, or contactless sensor (available separately). 200mm height adjustment.

1.0m wall hung WC frame



6/3 litres
500(w) x 1000(h) x 167 - 215mm(d)

1.0m frame TR9015 **£222.00**

Ideal for boxed in applications, especially under windows. Requires flush plate/button, or contactless sensor (available separately). 200mm height adjustment.

0.82m wall hung WC frame



6/3 litres
500(w) x 820(h) x 167 - 215mm(d)

0.82m frame TR9005 **£234.50**
Furniture Adaptor Kit TR9007 **£40.30**

Can be used with 600mm and wider furniture WC units. Use with Furniture Adaptor Kit, requires flush plate/button, or contactless sensor (available separately). 200mm height adjustment.

0.4m WC/bidet frame



400(w) x 400(h) x 170 - 335mm(d)

0.4m frame TR9018 **£108.50**

Compact half height WC frame suitable for use in narrow back to wall units including 500mm wide. For use with Torrent, Cascade or comfort height cisterns. Can also be used for bidets. 200mm height adjustment.

In-Wall cistern



6/3 litres
600(w) x 745 max(h) x 138 - 194mm(d)

Cistern TR9009 **£107.50**

Ideal for tiled in applications. All parts servicable through flush plate aperture.

Internal isolation valve, 150mm height adjustment. Top or front flush plate mounting. 1/2 BSP. Requires flush plate/button, or contactless sensor (available separately).

Comfort height cistern



6/3 litres
437(w) x 324(h) x 165mm(d)

With chrome flush button TR9008 **£94.60**

Developed specifically to allow comfort height back to wall pans to be used in 820mm high furniture.

Bottom entry inlet valve. Top or front flush plate mounting. 1/2 BSP PS insulation jacket. Pneumatic flush valve.

Torrent concealed dual flush cistern bottom inlet



6/3 litres
434(w) x 365(h) x 140mm(d)

With chrome flush button TR9001 **£94.60**

Bottom entry inlet valve. Top or front flush plate mounting. 1/2 BSP PS insulation jacket. Pneumatic flush valve.

Cascade concealed dual flush cistern side inlet



6/3 litres
434(w) x 365(h) x 140mm(d)

With chrome flush button TR9002 **£94.60**

Side entry bottom entry inlet valve. Top or front flush plate mounting. 1/2 BSP PS insulation jacket. Pneumatic flush valve.



Finishing Touches

WORKTOP OPTIONS

You have a choice of worktop styles, materials & finishes which perfectly complement our fitted furniture ranges.

Recreate the depth of natural stone with a Strata solid surface worktop. Choose from our extensive range of high quality, durable laminate surfaces, also available in a premium soft-touch option. Or give a smooth, uninterrupted finish to a fitted furniture run with a basin & integrated worktop, for a distinctly contemporary look & feel.



Strata solid surface



City basin



Soft touch laminate

STRATA SOLID SURFACE WORKTOPS

Strata worktops are an ideal solution for those wishing for an aspirational look & the feel of solid surface. The natural stone-like beauty of Strata solid surface makes them a perfect choice for your bathroom.

Strata worktops are completely solid and can be cut to whatever size or shape your bathroom demands, with no need to bond on finishing strips. Simply cut to the desired profile and sand down the end to a fine finish. Adhesive is also available in coordinating colours for joining longer runs or corner installations.

As with any solid surface product, darker finishes will show some scratches over time, however these can be very easily sanded and polished out to keep your worktop in pristine condition.

10 year guarantee.



Carrara



Grey Quartz



Arctic White



Ice White

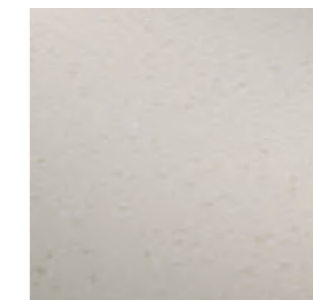

Glacier White



Jurassic

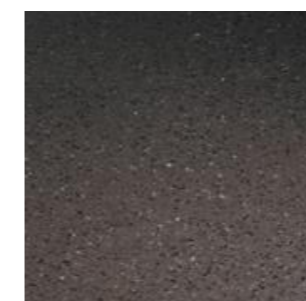

Stone Grey

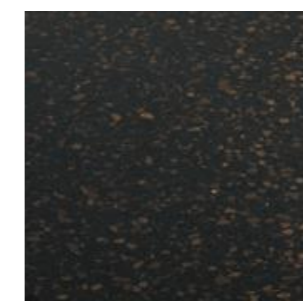

Copper



Galactic Black

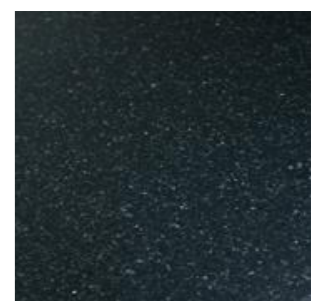

Starlight

BASINS WITH INTEGRATED WORKTOPS

Expertly moulded into a single piece, our basins with integrated worktops strike the perfect balance between form & function. Choose from the City basin or opt for the semi-recessed Motif basin style for a clean, minimalist look.

CITY BASIN

The natural beauty of the solid surface worktop flows effortlessly into the deep, spacious wash basin.

Provided in 1600mm length, the worktop can be cut down to size to suit your installation. To be used with 600mm semi-countertop units only, it works equally well with both classic and contemporary bathroom designs.



Right
City Basin
Solid surface basin with integrated worktop.
£610.00



MOTIF BASIN

The Motif basin is available in 1600mm length and the worktop can be cut down to size to suit your installation. Available in standard or slim depths and left or right handed versions. Motif is to be used with 600mm semi-countertop units only. It works equally well with both classic and contemporary bathroom designs.

Top
Motif Basin (left hand)
Solid surface basin with integrated worktop (standard depth).
£674.00



Bottom
Motif Basin (right hand)
Solid surface basin with integrated worktop (slim depth).
£539.00



SOFT TOUCH LAMINATE WORKTOPS

Pleasant to the touch, these super matt, premium laminate worktops are available in two on-trend shades. At 22mm they are slimmer in profile than standard laminate worktops & will help to create a striking, contemporary look for the fitted bathroom. The soft touch finish ensures they are easy to maintain, with the added benefit that fingerprints won't show.



Smoke

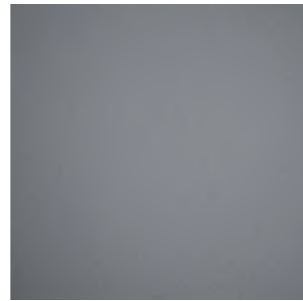

Shale



Shale soft touch laminate worktop shown

LAMINATE WORKTOPS

High quality & durable, our range of laminate worktops will add style to your bathroom. Specifically chosen to complement our extensive range of door & unit colours, a little inspiration will allow you to use the worktops in imaginative ways to create a striking effect.

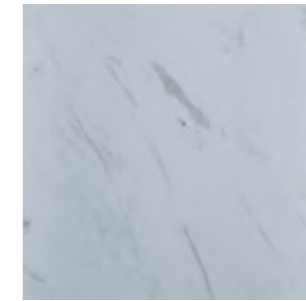

Massa Marble

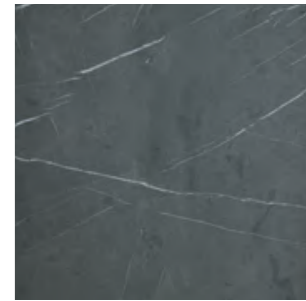

Grey Marble

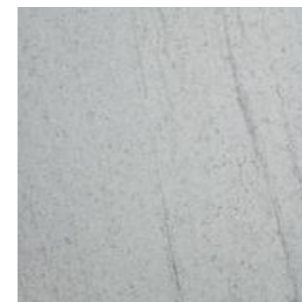

Portland Stone



White



White Sparkle

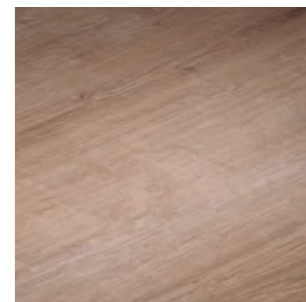

Natural Oak



Isadora Stone

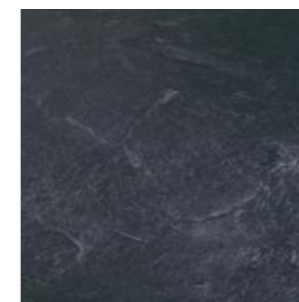

Riven Slate

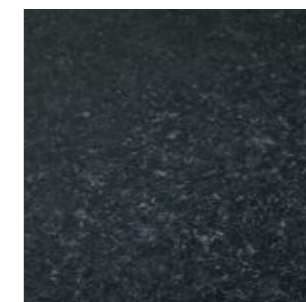

Black Granite



Black Sparkle

HANDLE COLLECTION

We have a comprehensive offer of handles & door knobs to complement our furniture ranges. From curved & rounded to sleek & contemporary.

Choose the handle that best reflects your chosen bathroom style. More information on our handle options can be found on page 107.

Handle Collection

Handle Type	Price	Handle Type	Price	Handle Type	Price	Handle Type	Price
1 Stockton Brass (available in 3 lengths)		4 Montana	£7.50	15 Utah	£19.00	24 Kansas (available in 7 lengths)	
128mm	£14.90	5 Seattle	£19.00	16 Columbus	£19.00	197mm	£14.90
320mm	£19.30	6 Vermont	£14.90	17 Daytona	£19.00	247mm	£16.90
492mm	£31.40	7 Madison	£19.00	18 Lexington	£27.10	297mm	£19.30
2 Stockton Chrome (available in 3 lengths)		8 Detroit	£19.00	19 Oakland	£19.00	347mm	£21.70
128mm	£14.90	9 Reno	£14.90	20 Portland Chrome 160mm	£19.00	397mm	£24.30
320mm	£19.30	10 Indiana	£7.50	21 Portland Brass 160mm	£19.00	552mm	£28.10
492mm	£31.40	11 Henderson	£7.80	22 Portland Chrome 32mm	£7.80	752mm	£32.80
3 Stockton Black (available in 3 lengths)		12 Carolina	£6.30	23 Portland Brass 32mm	£7.80		
128mm	£14.90	13 Washington Brass	£7.80				
320mm	£19.30	14 Washington Chrome	£7.80				
492mm	£31.40						

How to use the Kansas handle types

Unit	Handle	Code	No. Required
200 Cupboard Door Pack	197mm	FHKAN20.C	1
200 Toilet Roll Holder Door	197mm	FHKAN20.C	1
300 Cupboard Door Pack	297mm	FHKAN30.C	1
300 Twin Drawer Fascia Pack	297mm	FHKAN30.C	2
300 FHU Twin Door Pack	297mm	FHKAN30.C	2
400 Cupboard Door Pack	397mm	FHKAN40.C	1
500 SCT Unit Facia Pack	247mm	FHKAN25.C	2
600 SCT Unit Fascia Pack	297mm	FHKAN30.C	2
600 Wall Mounted Unit	552mm	FHKAN55.C	1
700 SCT Unit Facia Pack	347mm	FHKAN35.C	2
800 Wall Mounted Unit	752mm	FHKAN75.C	1



TAP COLLECTION

Designed to deliver the finishing touch to your bathroom, our basin mixers are not only beautiful to look at but superbly well engineered for durability too.

From ultra contemporary to more timeless designs, there is something to suit everyone. Many ranges include a mini basin mixer option, very useful for slim depth basins. Most taps also have a coordinating bath filler. Please refer to the main Roper Rhodes Bathroom Book for more information.

All Roper Rhodes taps use the latest highly reliable ceramic cartridge and ceramic disc technology. As testament to this in-built quality, all of our taps are provided with a ten year guarantee.



Hydra basin mixer with click waste
50(w) x 157(h) x 158mm(d)
Chrome finish T151102 **£157.00**



Hydra basin mixer with click waste
50(w) x 157(h) x 158mm(d)
Black finish T151103 **£157.00**



Hydra basin mixer with click waste
50(w) x 157(h) x 158mm(d)
Brass finish T151104 **£157.00**



Elate basin mixer with click waste
53(w) x 150(h) x 175mm(d)
Chrome finish T241102 **£178.50**



Elate basin mixer with click waste
53(w) x 150(h) x 175mm(d)
Black finish T241103 **£178.50**



Elate basin mixer with click waste
53(w) x 150(h) x 175mm(d)
Brass finish T241104 **£178.50**



Aim basin mixer with click waste
47(w) x 152(h) x 145mm(d)
Chrome finish T291102 **£118.50**



Veer basin mixer with click waste
139(w) x 145(h) x 166mm(d)
Chrome finish T301102 **£134.00**



Verse basin mixer with click waste
128(w) x 145(h) x 155mm(d)
Chrome finish T271102 **£130.00**



Poise basin mixer with click waste
80(w) x 175(h) x 180mm(d)
Chrome finish T231102 **£193.50**



Sign open spout basin mixer with click waste
55(w) x 175(h) x 150mm(d)
Chrome finish T171102 **£169.00**



Stream basin mixer with click waste
50(w) x 158(h) x 144mm(d)
Chrome finish T771002 **£160.00**



Code basin mixer with click waste
50(w) x 162(h) x 170mm(d)
Chrome finish T191102 **£148.50**



Image basin mixer with click waste
50(w) x 160(h) x 160mm(d)
Chrome finish T181102 **£148.50**



Sync basin mixer with click waste
52(w) x 150(h) x 155mm(d)
Chrome finish T201102 **£148.50**



Insight basin mixer with click waste
50(w) x 157(h) x 140mm(d)
Chrome finish T991002 **£142.50**



Factor basin mixer with click waste
46(w) x 160(h) x 151mm(d)
Chrome finish T131102 **£142.00**



Storm Basin Mixer with click waste
58(w) x 155(h) x 149mm(d)
Chrome finish T221002 **£125.00**



Wessex basin mixer with click waste
218(w) x 275(h) x 180mm(d)
Chrome finish T661002 **£202.00**



Henley basin mixer with pop up waste
224(w) x 117(h) x 167mm(d)
Chrome finish T261102 **£149.00**



For matching mini basin mixers, bath fillers and bath shower mixers, please see our Bathroom Book or visit roperrhodes.co.uk

LIGHTING OPTIONS

Lighting your bathroom couldn't be simpler with a variety of light fittings to enable you to create different effects. Creative lighting can greatly enhance a bathroom installation & generate a relaxing ambience.

The bathroom cabinets within our range of furniture feature a void behind the back panel, allowing wiring and transformers to be neatly concealed.

When planning your bathroom remember to make allowance for any electrical work which may have to be undertaken before any of your furniture is fitted. Always use a qualified electrician.



Above
LED Lighting
 Choose from two styles of overhead light, designed for use on top of cabinets or mirrors. There is a 6w 300mm chrome light and a 3w sweep chrome light available. Both benefit from the latest LED technology which provides a bright, practical task light with energy saving benefits. The lights are IP44 rated and supplied with an LED driver suitable for mounting outside zones 1 and 2. See diagram opposite.

Below
Air Backlit Mirror
 The Air backlit fluorescent mirror provides brilliant illumination. With special features such as a heated mirror pad, infra-red on/off switch and a recharging socket, it more than deserves its place in your bathroom. For alternative options see pages 114-115.

LIGHTING SCHEMATICS

300mm Chrome LED light



Sweep Chrome LED Light

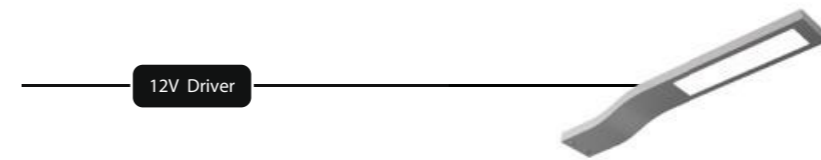

Zones for equipment in close proximity to baths & showers

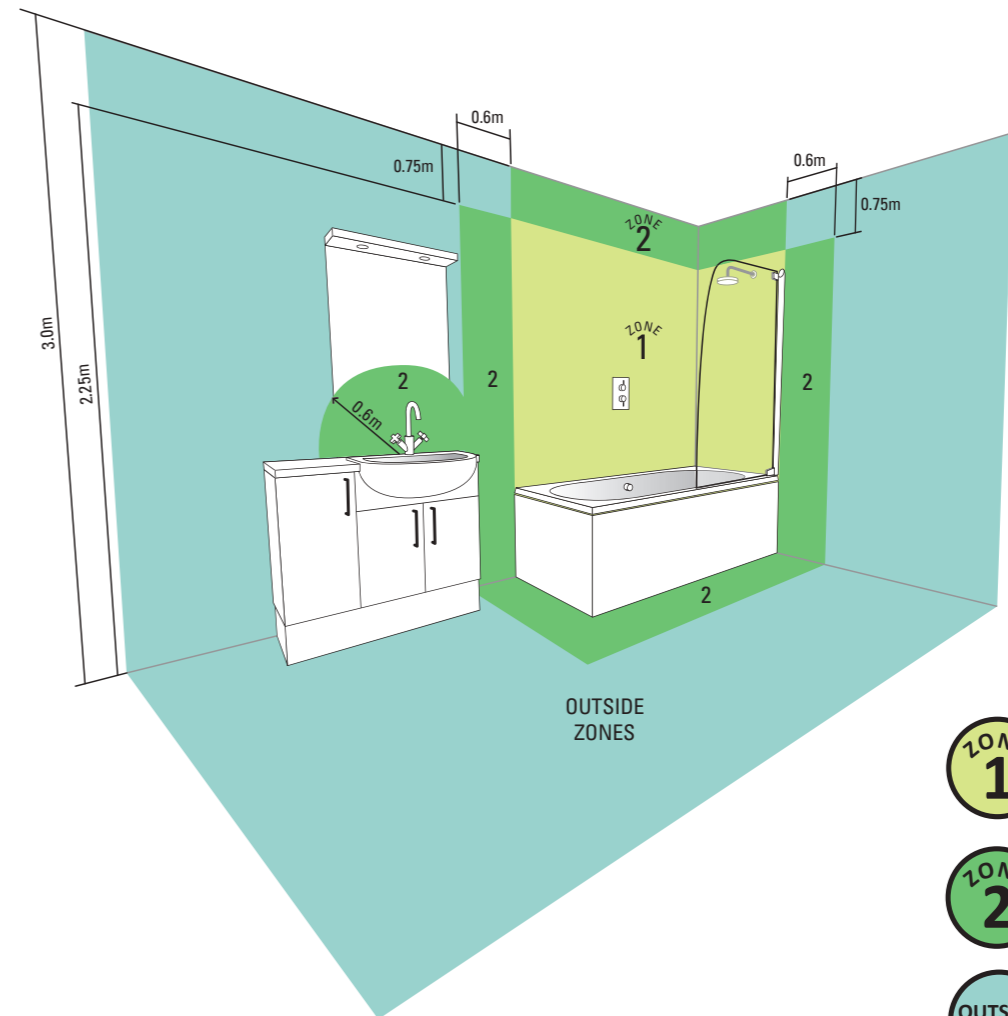

- ZONE 1** Electrical fittings in this zone require separated extra low voltage and a minimum rating of IP44 (splash-proof).
- ZONE 2** Electrical fittings in this zone require a minimum rating of IP44 (splash-proof).
- OUTSIDE ZONES** Electrical fittings in this zone require a minimum rating of IP20.



Technical Information

STANDARD DEPTH UNITS

500mm standard depth back to wall WC unit with fascia/door pack



Finish

Burford Standard WC

Derwent Blue
Mercury
Chalk White
Mocha
Pebble Grey
Slate Grey

Comfort Height WC

Derwent Blue
Mercury
Chalk White
Mocha
Pebble Grey
Slate Grey

Aruba

Derwent Blue
Alpine Elm
Charcoal Elm
Gloss Dark Clay
Mercury
Mocha
Flintwood
Natural Oak
Washed Oak
White

Vetro

Light Grey
White
Cinder

Capella

White

Recommended Carcass

F3BW5.D - Graphite
F3BW5.D - Graphite
F3BW5.OK - Natural Oak
F3BW5.OK - Natural Oak
F3BW5.OK - Natural Oak
F3BW5.OK - Natural Oak

F3BW5.D - Graphite
F3BW5.D - Graphite
F3BW5.OK - Natural Oak
F3BW5.OK - Natural Oak
F3BW5.OK - Natural Oak
F3BW5.OK - Natural Oak

F3BW5.D - Graphite
F3BW5.G - Silver
F3BW5.D - Graphite
F3BW5.D - Graphite
F3BW5.OK - Natural Oak
F3BW5.D - Graphite
F3BW5.OK - Natural Oak
F3BW5.G - Silver
F3BW5.W - White

F3BW5.G - Silver
F3BW5.G - Silver
F3BW5.D - Graphite

F3BW5.W - White

Fascia/Door Pack

DBW5.DB
DBW5.MY
DBW5.CW
DBW5.MC
DBW5.PG
DBW5.SG

ABW5.DB *
ABW5.MY *
ABW5.CW *
ABW5.MC *
ABW5.PG *
ABW5.SG *

ABW5.DB
ABW5.AE
ABW5.CE
ABW5.GDC
ABW5.MY
ABW5.MC
ABW5.FW
ABW5.OK
ABW5.WO
ABW5.W

VBW5.VG
VBW5.VW
VBW5.VC

CBW5.W

Features

- Fascia to be cut on site to suit sanitaryware
- Main panel goes to floor
- Front access top fascia
- For compatible back to wall WCs see pages 116-118

* These fascia packs are designed to be used with comfort height WC pans & cisterns, so exclude the Burford moulding

Total £393.00

£255.00

£138.00

600mm standard depth back to wall WC unit with fascia/door pack



Burford Standard WC

Derwent Blue
Mercury
Chalk White
Mocha
Pebble Grey
Slate Grey

Comfort Height WC

Derwent Blue
Mercury
Chalk White
Mocha
Pebble Grey
Slate Grey

Aruba

Derwent Blue
Alpine Elm
Charcoal Elm
Gloss Dark Clay
Mercury
Mocha
Flintwood
Natural Oak
Washed Oak
White

Vetro

Light Grey
White
Cinder

Capella

White

F3BW6.D - Graphite
F3BW6.D - Graphite
F3BW6.OK - Natural Oak
F3BW6.OK - Natural Oak
F3BW6.OK - Natural Oak
F3BW6.OK - Natural Oak

F3BW6.D - Graphite
F3BW6.D - Graphite
F3BW6.OK - Natural Oak
F3BW6.OK - Natural Oak
F3BW6.OK - Natural Oak
F3BW6.OK - Natural Oak

F3BW6.D - Graphite
F3BW6.G - Silver
F3BW6.D - Graphite
F3BW6.D - Graphite
F3BW6.D - Graphite
F3BW6.OK - Natural Oak
F3BW6.D - Graphite
F3BW6.OK - Natural Oak
F3BW6.OK - Natural Oak
F3BW6.G - Silver
F3BW6.W - White

F3BW6.G - Silver
F3BW6.G - Silver
F3BW6.D - Graphite

F3BW6.W - White

DBW6.DB
DBW6.MY
DBW6.CW
DBW6.MC
DBW6.PG
DBW6.SG

ABW6.DB *
ABW6.MY *
ABW6.CW *
ABW6.MC *
ABW6.PG *
ABW6.SG *

ABW6.DB
ABW6.AE
ABW6.CE
ABW6.GDC
ABW6.MY
ABW6.MC
ABW6.FW
ABW6.OK
ABW6.WO
ABW6.W

VBW6.VG
VBW6.VW
VBW6.VC

CBW6.W

Features

- Fascia to be cut on site to suit sanitaryware
- Main panel goes to floor
- Front access top fascia
- For compatible back to wall WCs see pages 116-118

* These fascia packs are designed to be used with comfort height WC pans & cisterns, so exclude the Burford moulding

Total £426.50

£272.00

£154.50



Exposed carcass sides are covered by using colour matched end panels which will be required to complete your fitted furniture run. See pages 111-112 for panel options.



Most freestanding units require a colour matched plinth to be installed to cover any pipework underneath the units. See pages 112-113 for plinth options.

STANDARD DEPTH UNITS

500mm standard depth basin unit with fascia/door pack

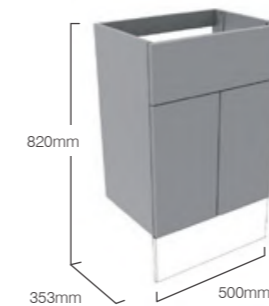

Finish

Burford

Derwent Blue
Mercury
Chalk White
Mocha
Pebble Grey
Slate Grey

Aruba

Derwent Blue
Alpine Elm
Charcoal Elm
Gloss Dark Clay
Mercury
Mocha
Flintwood
Natural Oak
Washed Oak
White

Vetro

Light Grey
White
Cinder

Capella

White

Recommended Carcass

F3SC5.D - Graphite
F3SC5.D - Graphite
F3SC5.OK - Natural Oak
F3SC5.OK - Natural Oak
F3SC5.OK - Natural Oak
F3SC5.OK - Natural Oak

F3SC5.D - Graphite
F3SC5.G - Silver
F3SC5.D - Graphite
F3SC5.D - Graphite
F3SC5.D - Graphite
F3SC5.OK - Natural Oak
F3SC5.D - Graphite
F3SC5.OK - Natural Oak
F3SC5.G - Silver
F3SC5.W - White

F3SC5.G - Silver
F3SC5.G - Silver
F3SC5.D - Graphite

F3SC5.W - White

Fascia/Door Pack

DSC5.DB
DSC5.MY
DSC5.CW
DSC5.MC
DSC5.PG
DSC5.SG

ASC5.DB
ASC5.AE
ASC5.CE
ASC5.GDC
ASC5.MY
ASC5.MC
ASC5.FW
ASC5.OK
ASC5.WO
ASC5.W

CSC5.W

Features

- Fascia to be cut on site to suit sanitaryware
- One adjustable shelf
- Soft close hinges
- Removable back panel
- For compatible basins see pages 122-123
- A plinth is required for this unit - see pages 112-113

Total £378.00

£237.50

£140.50

600mm standard depth basin unit with fascia/door pack

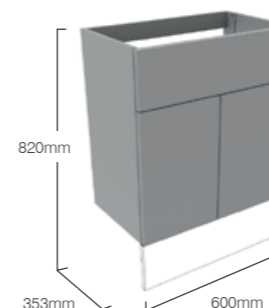

Burford

Derwent Blue
Mercury
Chalk White
Mocha
Pebble Grey
Slate Grey

Aruba

Derwent Blue
Alpine Elm
Charcoal Elm
Gloss Dark Clay
Mercury
Mocha
Flintwood
Natural Oak
Washed Oak
White

Vetro

Light Grey
White
Cinder

Capella

White

F3SC6.D - Graphite
F3SC6.D - Graphite
F3SC6.OK - Natural Oak
F3SC6.OK - Natural Oak
F3SC6.OK - Natural Oak
F3SC6.OK - Natural Oak

F3SC6.D - Graphite
F3SC6.G - Silver
F3SC6.D - Graphite
F3SC6.D - Graphite
F3SC6.D - Graphite
F3SC6.OK - Natural Oak
F3SC6.D - Graphite
F3SC6.OK - Natural Oak
F3SC6.G - Silver
F3SC6.W - White

F3SC6.G - Silver
F3SC6.G - Silver
F3SC6.D - Graphite

F3SC6.W - White

DSC6.DB
DSC6.MY
DSC6.CW
DSC6.MC
DSC6.PG
DSC6.SG

ASC6.DB
ASC6.AE
ASC6.CE
ASC6.GDC
ASC6.MY
ASC6.MC
ASC6.FW
ASC6.OK
ASC6.WO
ASC6.W

CSC6.W

Features

- Fascia to be cut on site to suit sanitaryware
- One adjustable shelf
- Soft close hinges
- Removable back panel
- For compatible basins see pages 122-123
- A plinth is required for this unit - see pages 112-113

Total £428.50

£274.00

£154.50



Exposed carcass sides are covered by using colour matched end panels which will be required to complete your fitted furniture run. See pages 111-112 for panel options.



Most freestanding units require a colour matched plinth to be installed to cover any pipework underneath the units. See pages 112-113 for plinth options.

STANDARD DEPTH UNITS

700mm standard depth basin unit with fascia/door pack

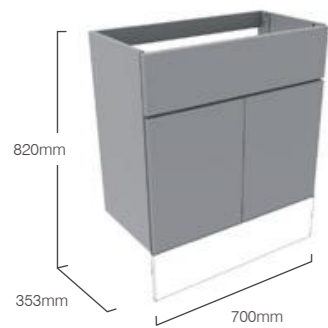

Finish	Recommended Carcass	Fascia/Door Pack
Burford		
Derwent Blue	F3SC7.D - Graphite	DSC7.DB
Mercury	F3SC7.D - Graphite	DSC7.MY
Chalk White	F3SC7.OK - Natural Oak	DSC7.CW
Mocha	F3SC7.OK - Natural Oak	DSC7.MC
Pebble Grey	F3SC7.OK - Natural Oak	DSC7.PG
Slate Grey	F3SC7.OK - Natural Oak	DSC7.SG
Aruba		
Derwent Blue	F3SC7.D - Graphite	ASC7.DB
Alpine Elm	GF3SC7.G - Silver	ASC7.AE
Charcoal Elm	F3SC7.D - Graphite	ASC7.CE
Gloss Dark Clay	F3SC7.D - Graphite	ASC7.GDC
Mercury	F3SC7.D - Graphite	ASC7.MY
Mocha	F3SC7.OK - Natural Oak	ASC7.MC
Flintwood	F3SC7.D - Graphite	ASC7.FW
Natural Oak	F3SC7.OK - Natural Oak	ASC7.OK
Washed Oak	F3SC7.G - Silver	ASC7.WO
White	F3SC7.W - White	ASC7.W
Vetro		
Light Grey	F3SC7.G - Silver	VSC7.VG
White	F3SC7.G - Silver	VSC7.VW
Cinder	F3SC7.D - Graphite	VSC7.VC
Capella		
White	F3SC7.W - White	CSC7.W
Total	£282.00	£171.00

Features

- Fascia to be cut on site to suit sanitaryware
- One adjustable shelf
- Soft close hinges
- Removable back panel
- For compatible basins see pages 122-123
- A plinth is required for this unit - see pages 112-113

Total £453.00

200mm standard depth floor cupboard with fascia/door pack

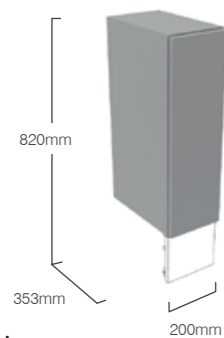

Finish	Recommended Carcass	Fascia/Door Pack
Burford		
Derwent Blue *	F3FC2.D - Graphite	DFC2.DB
Mercury *	F3FC2.OK - Natural Oak	AFC2.MY
Chalk White *	F3FC2.OK - Natural Oak	DFC2.CW
Mocha *	F3FC2.OK - Natural Oak	DFC2.MC
Pebble Grey *	F3FC2.OK - Natural Oak	DFC2.PG
Slate Grey *	F3FC2.OK - Natural Oak	DFC2.SG
Aruba		
Derwent Blue	F3FC2.D - Graphite	AFC2.DB
Alpine Elm	F3FC2.G - Silver	AFC2.AE
Charcoal Elm	F3FC2.D - Graphite	AFC2.CE
Gloss Dark Clay	F3FC2.D - Graphite	AFC2.GDC
Mercury	F3FC2.D - Graphite	AFC2.MY
Mocha	F3FC2.OK - Natural Oak	DFC2.MC
Flintwood	F3FC2.D - Graphite	AFC2.FW
Natural Oak	F3FC2.OK - Natural Oak	AFC2.OK
Washed Oak	F3FC2.G - Silver	AFC2.WO
White	F3FC2.W - White	AFC2.W
Vetro		
Light Grey	F3FC2.G - Silver	VFC2.VG
White	F3FC2.G - Silver	VFC2.VW
Cinder	F3FC2.D - Graphite	VFC2.VC
Capella		
White	F3FC2.W - White	CFC2.W
Total	£186.50	£51.30

Features

- Soft close hinges
- One adjustable shelf
- Reversible door
- A plinth is required for this unit - see pages 112-113

* These products have plain fronted fascia packs

Total £237.80



Exposed carcass sides are covered by using colour matched end panels which will be required to complete your fitted furniture run. See pages 111-112 for panel options.



Most freestanding units require a colour matched plinth to be installed to cover any pipework underneath the units. See pages 112-113 for plinth options.

STANDARD DEPTH UNITS

300mm standard depth floor cupboard with fascia/door pack

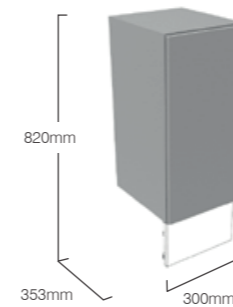

Finish	Recommended Carcass	Fascia/Door Pack
Burford		
Derwent Blue	F3FC3.D - Graphite	DFC3.DB
Mercury	F3FC3.D - Graphite	DFC3.MY
Chalk White	F3FC3.OK - Natural Oak	DFC3.CW
Mocha	F3FC3.OK - Natural Oak	DFC3.MC
Pebble Grey	F3FC3.OK - Natural Oak	DFC3.PG
Slate Grey	F3FC3.OK - Natural Oak	DFC3.SG
Aruba		
Derwent Blue	F3FC3.D - Graphite	AFC3.DB
Alpine Elm	F3FC3.G - Silver	AFC3.AE
Charcoal Elm	F3FC3.D - Graphite	AFC3.CE
Gloss Dark Clay	F3FC3.D - Graphite	AFC3.GDC
Mercury	F3FC3.D - Graphite	AFC3.MY
Mocha	F3FC3.OK - Natural Oak	AFC3.MC
Flintwood	F3FC3.D - Graphite	AFC3.FW
Natural Oak	F3FC3.OK - Natural Oak	AFC3.OK
Washed Oak	F3FC3.G - Silver	AFC3.WO
White	F3FC3.W - White	AFC3.W
Vetro		
Light Grey	F3FC3.G - Silver	VFC3.VG
White	F3FC3.G - Silver	VFC3.VW
Cinder	F3FC3.D - Graphite	VFC3.VC
Capella		
White	F3FC3.W - White	CFC3.W
Total	£194.50	£59.80

Features

- Soft close hinges
- One adjustable shelf
- Reversible door
- A plinth is required for this unit - see pages 112-113

Total £254.30

400mm standard depth floor cupboard with fascia/door pack

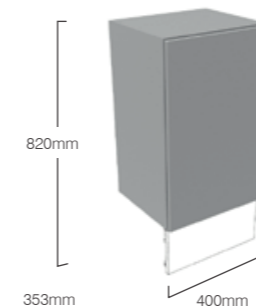

Finish	Recommended Carcass	Fascia/Door Pack
Burford		
Derwent Blue	F3FC4.D - Graphite	DFC4.DB
Mercury	F3FC4.D - Graphite	DFC4.MY
Chalk White	F3FC4.OK - Natural Oak	DFC4.CW
Mocha	F3FC4.OK - Natural Oak	DFC4.MC
Pebble Grey	F3FC4.OK - Natural Oak	DFC4.PG
Slate Grey	F3FC4.OK - Natural Oak	DFC4.SG
Aruba		
Derwent Blue	F3FC4.D - Graphite	AFC4.DB
Alpine Elm	F3FC4.G - Silver	AFC4.AE
Charcoal Elm	F3FC4.D - Graphite	AFC4.CE
Gloss Dark Clay	F3FC4.D - Graphite	AFC4.GDC
Mercury	F3FC4.D - Graphite	AFC4.MY
Mocha	F3FC4.OK - Natural Oak	AFC4.MC
Flintwood	F3FC4.D - Graphite	AFC4.FW
Natural Oak	F3FC4.OK - Natural Oak	AFC4.OK
Washed Oak	F3FC4.G - Silver	AFC4.WO
White	F3FC4.W - White	AFC4.W
Vetro		
Light Grey	F3FC4.G - Silver	VFC4.VG
White	F3FC4.G - Silver	VFC4.VW
Cinder	F3FC4.D - Graphite	VFC4.VC
Capella		
White	F3FC4.W - White	CFC4.W
Total	£221.00	£68.30

Features

- Soft close hinges
- One adjustable shelf
- Reversible door
- A plinth is required for this unit - see pages 112-113

Total £289.30



Exposed carcass sides are covered by using colour matched end panels which will be required to complete your fitted furniture run. See pages 111-112 for panel options.



Most freestanding units require a colour matched plinth to be installed to cover any pipework underneath the units. See pages 112-113 for plinth options.

STANDARD DEPTH UNITS

600mm standard depth floor cupboard with fascia/door pack

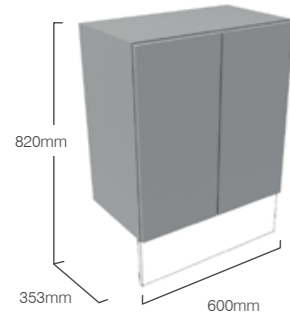

Finish	Recommended Carcass	Fascia/Door Pack
Burford Derwent Blue Mercury Chalk White Mocha Pebble Grey Slate Grey	F3FC6.D - Graphite F3FC6.D - Graphite F3FC6.OK - Natural Oak F3FC6.OK - Natural Oak F3FC6.OK - Natural Oak F3FC6.OK - Natural Oak	DFC3.DB x2 DFC3.MY x2 DFC3.CW x2 DFC3.MC x2 DFC3.PG x2 DFC3.SG x2
Aruba Derwent Blue Alpine Elm Charcoal Elm Gloss Dark Clay Mercury Mocha Flintwood Natural Oak Washed Oak White	F3FC6.D - Graphite F3FC6.G - Silver F3FC6.D - Graphite F3FC6.D - Graphite F3FC6.D - Graphite F3FC6.OK - Natural Oak F3FC6.D - Graphite F3FC6.OK - Natural Oak F3FC6.G - Silver F3FC6.W - White	AFC3.DB x2 AFC3.AE x2 AFC3.CE x2 AFC3.GDC x2 AFC3.MY x2 AFC3.MC x2 AFC3.FW x2 AFC3.OK x2 AFC3.WO x2 AFC3.W x2
Vetro Light Grey White Cinder	F3FC6.G - Silver F3FC6.G - Silver F3FC6.D - Graphite	VFC3.VG x2 VFC3.VW x2 VFC3.VC x2
Capella White	F3FC6.W - White	CFC3.W x2

- Features**
- Soft close hinges
 - One adjustable shelf
 - A plinth is required for this unit - see pages 112-113

Total £370.60

300mm standard depth shelf storage unit

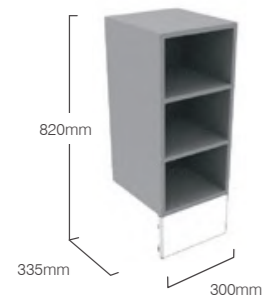

- Can be cut down to suit odd size space in furniture run
- Supplied for self assembly
- A plinth is required for this unit - see pages 112-113

F3SS3.D - Graphite	F3SS3.OK - Natural Oak	F3SS3.W - White	F3SS3.G - Silver
--------------------	------------------------	-----------------	------------------

Total £146.00

300mm standard depth twin drawer unit with fascia/door pack

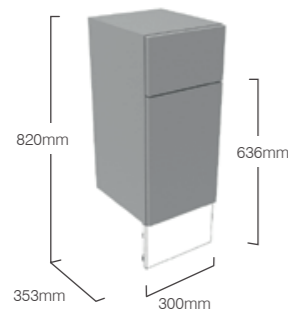

Burford Derwent Blue Mercury Chalk White Mocha Pebble Grey Slate Grey	F3DS3.D - Graphite F3DS3.D - Graphite F3DS3.OK - Natural Oak F3DS3.OK - Natural Oak F3DS3.OK - Natural Oak F3DS3.OK - Natural Oak	DDS3.DB DDS3.MY DDS3.CW DDS3.MC DDS3.PG DDS3.SG
Aruba Derwent Blue Alpine Elm Charcoal Elm Gloss Dark Clay Mercury Mocha Flintwood Natural Oak Washed Oak White	F3DS3.D - Graphite F3DS3.G - Silver F3DS3.D - Graphite F3DS3.D - Graphite F3DS3.D - Graphite F3DS3.OK - Natural Oak F3DS3.D - Graphite F3DS3.OK - Natural Oak F3DS3.G - Silver F3DS3.W - White	ADS3.DB ADS3.AE ADS3.CE ADS3.GDC ADS3.MY ADS3.MC ADS3.FW ADS3.OK ADS3.WO ADS3.W
Vetro Light Grey White Cinder	F3DS3.G - Silver F3DS3.G - Silver F3DS3.D - Graphite	VDS3.VG VDS3.VW VDS3.VC
Capella White	F3DS3.W - White	CDS3.W

- Features**
- One large and one small soft close drawer
 - Fascias easily aligned
 - Non-slip rubber matting in drawers
 - A plinth is required for this unit - see pages 112-113

Total £574.80

END PANELS REQUIRED
Exposed carcass sides are covered by using colour matched end panels which will be required to complete your fitted furniture run. See pages 111-112 for panel options.

PLINTH REQUIRED
Most freestanding units require a colour matched plinth to be installed to cover any pipework underneath the units. See pages 112-113 for plinth options.

STANDARD DEPTH UNITS

300mm standard depth triple drawer unit with fascia/door pack



Finish	Recommended Carcass	Fascia/Door Pack
Burford Derwent Blue * Mercury * Chalk White * Mocha * Pebble Grey * Slate Grey *	F33DR.D - Graphite F33DR.D - Graphite F33DR.OK - Natural Oak F33DR.OK - Natural Oak F33DR.OK - Natural Oak F33DR.OK - Natural Oak	D3DR.DB D3DR.MY D3DR.CW D3DR.MC D3DR.PG D3DR.SG
Aruba Derwent Blue Alpine Elm Charcoal Elm Gloss Dark Clay Mercury Mocha Flintwood Natural Oak Washed Oak White	F33DR.D - Graphite F33DR.G - Silver F33DR.D - Graphite F33DR.D - Graphite F33DR.D - Graphite F33DR.D - Graphite F33DR.OK - Natural Oak F33DR.OK - Natural Oak F33DR.OK - Natural Oak F33DR.G - Silver F33DR.W - White	A3DR.DB A3DR.AE A3DR.CE A3DR.GDC A3DR.MY A3DR.MC A3DR.FW A3DR.OK A3DR.WO A3DR.W
Vetro Light Grey White Cinder	F33DR.G - Silver F33DR.G - Silver F33DR.D - Graphite	V3DR.VG V3DR.VW V3DR.VC
Capella White	F33DR.W - White	C3DR.W

- Features**
- Soft close drawers
 - Fascias easily aligned
 - Non-slip rubber matting in drawers
 - A plinth is required for this unit - see pages 112-113

* These products have plain fronted fascia packs

Total £584.10

200mm standard depth toilet roll holder cupboard with fascia/door pack

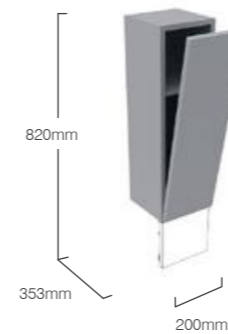

Burford Derwent Blue * Mercury * Chalk White * Mocha * Pebble Grey * Slate Grey *	F3TR2.D - Graphite F3TR2.D - Graphite F3TR2.OK - Natural Oak F3TR2.OK - Natural Oak F3TR2.OK - Natural Oak F3TR2.OK - Natural Oak	DTR2.DB ATR2.MY DTR2.CW DTR2.MC DTR2.PG DTR2.SG
Aruba Derwent Blue Alpine Elm Charcoal Elm Gloss Dark Clay Mercury Mocha Flintwood Natural Oak Washed Oak White	F3TR2.D - Graphite F3TR2.G - Silver F3TR2.D - Graphite F3TR2.D - Graphite F3TR2.D - Graphite F3TR2.OK - Natural Oak F3TR2.D - Graphite F3TR2.OK - Natural Oak F3TR2.G - Silver F3TR2.W - White	ATR2.DB ATR2.AE ATR2.CE ATR2.GDC ATR2.MY DTR2.MC ATR2.FW ATR2.OK ATR2.WO ATR2.W
Vetro Light Grey White Cinder	F3TR2.G - Silver F3TR2.G - Silver F3TR2.D - Graphite	VTR2.VG VTR2.VW VTR2.VC
Capella White	F3TR2.W - White	CTR2.W

- Features**
- Pull down door (plain door on Burford)
 - Toilet roll stored on back of door
 - A plinth is required for this unit - see pages 112-113

* These products have plain fronted fascia packs

Total £333.30

END PANELS REQUIRED
Exposed carcass sides are covered by using colour matched end panels which will be required to complete your fitted furniture run. See pages 111-112 for panel options.

PLINTH REQUIRED
Most freestanding units require a colour matched plinth to be installed to cover any pipework underneath the units. See pages 112-113 for plinth options.

STANDARD DEPTH UNITS

300mm standard depth full height twin door cupboard with fascia/door pack

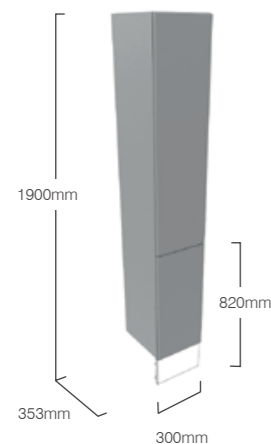

Burford

Derwent Blue
Mercury
Chalk White
Mocha
Pebble Grey
Slate Grey

F3FHU3.D - Graphite
F3FHU3.D - Graphite
F3FHU3.OK - Natural Oak
F3FHU3.OK - Natural Oak
F3FHU3.OK - Natural Oak
F3FHU3.OK - Natural Oak

DFHU3.DB
DFHU3.MY
DFHU3.CW
DFHU3.MC
DFHU3.PG
DFHU3.SG

Aruba

Derwent Blue
Alpine Elm
Charcoal Elm
Gloss Dark Clay
Mercury
Mocha
Flintwood
Natural Oak
Washed Oak
White

F3FHU3.D - Graphite
F3FHU3.G - Silver
F3FHU3.D - Graphite
F3FHU3.D - Graphite
F3FHU3.D - Graphite
F3FHU3.OK - Natural Oak
F3FHU3.D - Graphite
F3FHU3.OK - Natural Oak
F3FHU3.G - Silver
F3FHU3.W - White

AFHU3.DB
AFHU3.AE
AFHU3.CE
AFHU3.GDC
AFHU3.MY
AFHU3.MC
AFHU3.FW
AFHU3.OK
AFHU3.WO
AFHU3.W

Vetro

Light Grey
White
Cinder

F3FHU3.G - Silver
F3FHU3.G - Silver
F3FHU3.D - Graphite

VFHU3.VG
VFHU3.VW
VFHU3.VC

Capella

White

F3FHU3.W - White

CFHU3.W

Features

- Soft close hinges
- Two adjustable glass shelves in top section
- One wooden adjustable shelf in base
- A plinth is required for this unit - see pages 112-113

Total £506.00

£377.00

£129.00



Exposed carcass sides are covered by using colour matched end panels which will be required to complete your fitted furniture run. See pages 111-112 for panel options.



Most freestanding units require a colour matched plinth to be installed to cover any pipework underneath the units. See pages 112-113 for plinth options.

SLIM DEPTH UNITS

500mm slim depth back to wall WC unit with fascia/door pack



Features

- Fascia to be cut on site to suit sanitaryware
- Main panel goes to floor
- Front access top fascia
- For compatible back to wall WCs see pages 116-118

* These fascia packs are designed to be used with comfort height WC pans & cisterns, so exclude the Burford moulding

Total £375.00

£237.00

£138.00

Finish

Burford Standard WC

Derwent Blue
Mercury
Chalk White
Mocha
Pebble Grey
Slate Grey

Recommended Carcass

F2BW5.D - Graphite
F2BW5.D - Graphite
F2BW5.OK - Natural Oak
F2BW5.OK - Natural Oak
F2BW5.OK - Natural Oak
F2BW5.OK - Natural Oak

Fascia/Door Pack

DBW5.DB
DBW5.MY
DBW5.CW
DBW5.MC
DBW5.PG
DBW5.SG

Comfort Height WC

Derwent Blue
Mercury
Chalk White
Mocha
Pebble Grey
Slate Grey

F2BW5.D - Graphite
F2BW5.D - Graphite
F2BW5.OK - Natural Oak
F2BW5.OK - Natural Oak
F2BW5.OK - Natural Oak
F2BW5.OK - Natural Oak

ABW5.DB *
ABW5.MY *
ABW5.CW *
ABW5.MC *
ABW5.PG *
ABW5.SG *

Aruba

Derwent Blue
Alpine Elm
Charcoal Elm
Gloss Dark Clay
Mercury
Mocha
Flintwood
Natural Oak
Washed Oak
White

F2BW5.D - Graphite
F2BW5.G - Silver
F2BW5.D - Graphite
F2BW5.D - Graphite
F2BW5.D - Graphite
F2BW5.OK - Natural Oak
F2BW5.D - Graphite
F2BW5.OK - Natural Oak
F2BW5.G - Silver
F2BW5.W - White

ABW5.DB
ABW5.AE
ABW5.CE
ABW5.GDC
ABW5.MY
ABW5.MC
ABW5.FW
ABW5.OK
ABW5.WO
ABW5.W

Vetro

Light Grey
White
Cinder

F2BW5.G - Silver
F2BW5.G - Silver
F2BW5.D - Graphite

VBW5.VG
VBW5.VW
VBW5.VC

Capella

White

F2BW5.W - White

CBW5.W

600mm slim depth back to wall WC unit with fascia/door pack



Features

- Fascia to be cut on site to suit sanitaryware
- Main panel goes to floor
- Front access top fascia
- For compatible back to wall WCs see pages 116-118

* These fascia packs are designed to be used with comfort height WC pans & cisterns, so exclude the Burford moulding

Total £409.50

£255.00

£154.50

Burford Standard WC

Derwent Blue
Mercury
Chalk White
Mocha
Pebble Grey
Slate Grey

F2BW6.D - Graphite
F2BW6.D - Graphite
F2BW6.OK - Natural Oak
F2BW6.OK - Natural Oak
F2BW6.OK - Natural Oak
F2BW6.OK - Natural Oak

DBW6.DB
DBW6.MY
DBW6.CW
DBW6.MC
DBW6.PG
DBW6.SG

Comfort Height WC

Derwent Blue
Mercury
Chalk White
Mocha
Pebble Grey
Slate Grey

F2BW6.D - Graphite
F2BW6.D - Graphite
F2BW6.OK - Natural Oak
F2BW6.OK - Natural Oak
F2BW6.OK - Natural Oak
F2BW6.OK - Natural Oak

ABW6.DB *
ABW6.MY *
ABW6.CW *
ABW6.MC *
ABW6.PG *
ABW6.SG *

Aruba

Derwent Blue
Alpine Elm
Charcoal Elm
Gloss Dark Clay
Mercury
Mocha
Flintwood
Natural Oak
Washed Oak
White

F2BW6.D - Graphite
F2BW6.G - Silver
F2BW6.D - Graphite
F2BW6.D - Graphite
F2BW6.D - Graphite
F2BW6.OK - Natural Oak
F2BW6.D - Graphite
F2BW6.OK - Natural Oak
F2BW6.G - Silver
F2BW6.W - White

ABW6.DB
ABW6.AE
ABW6.CE
ABW6.GDC
ABW6.MY
ABW6.MC
ABW6.FW
ABW6.OK
ABW6.WO
ABW6.W

Vetro

Light Grey
White
Cinder

F2BW6.G - Silver
F2BW6.G - Silver
F2BW6.D - Graphite

VBW6.VG
VBW6.VW
VBW6.VC

Capella

White

F2BW6.W - White

CBW6.W



Exposed carcass sides are covered by using colour matched end panels which will be required to complete your fitted furniture run. See pages 111-112 for panel options.



Most freestanding units require a colour matched plinth to be installed to cover any pipework underneath the units. See pages 112-113 for plinth options.

SLIM DEPTH UNITS

500mm slim depth basin unit with fascia/door pack

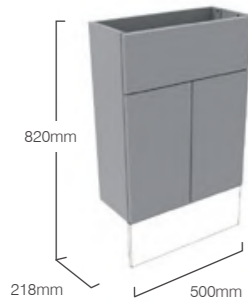

Finish	Recommended Carcass	Fascia/Door Pack
Burford		
Derwent Blue	F2SC5.D - Graphite	DSC5.DB
Mercury	F2SC5.D - Graphite	DSC5.MY
Chalk White	F2SC5.OK - Natural Oak	DSC5.CW
Mocha	F2SC5.OK - Natural Oak	DSC5.MC
Pebble Grey	F2SC5.OK - Natural Oak	DSC5.PG
Slate Grey	F2SC5.OK - Natural Oak	DSC5.SG
Aruba		
Derwent Blue	F2SC5.D - Graphite	ASC5.DB
Alpine Elm	F2SC5.G - Silver	ASC5.AE
Charcoal Elm	F2SC5.D - Graphite	ASC5.CE
Gloss Dark Clay	F2SC5.D - Graphite	ASC5.GDC
Mercury	F2SC5.D - Graphite	ASC5.MY
Mocha	F2SC5.OK - Natural Oak	ASC5.MC
Flintwood	F2SC5.D - Graphite	ASC5.FW
Natural Oak	F2SC5.OK - Natural Oak	ASC5.OK
Washed Oak	F2SC5.G - Silver	ASC5.WO
White	F2SC5.W - White	ASC5.W
Vetro		
Light Grey	F2SC5.G - Silver	VSC5.VG
White	F2SC5.G - Silver	VSC5.VW
Cinder	F2SC5.D - Graphite	VSC5.VC
Capella		
White	F2SC5.W - White	CSC5.W

Features

- Fascia to be cut on site to suit sanitaryware
- One adjustable shelf
- Soft close hinges
- Removable back panel
- For compatible basins see pages 122-123
- A plinth is required for this unit - see pages 112-113

Total £372.00

£231.50

£140.50

600mm slim depth basin unit with fascia/door pack

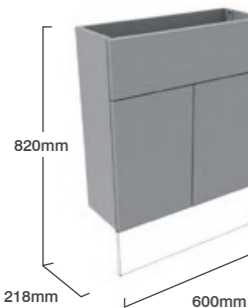

Burford		
Derwent Blue	F2SC6.D - Graphite	DSC6.DB
Mercury	F2SC6.D - Graphite	DSC6.MY
Chalk White	F2SC6.OK - Natural Oak	DSC6.CW
Mocha	F2SC6.OK - Natural Oak	DSC6.MC
Pebble Grey	F2SC6.OK - Natural Oak	DSC6.PG
Slate Grey	F2SC6.OK - Natural Oak	DSC6.SG
Aruba		
Derwent Blue	F2SC6.D - Graphite	ASC6.DB
Alpine Elm	F2SC6.G - Silver	ASC6.AE
Charcoal Elm	F2SC6.D - Graphite	ASC6.CE
Gloss Dark Clay	F2SC6.D - Graphite	ASC6.GDC
Mercury	F2SC6.D - Graphite	ASC6.MY
Mocha	F2SC6.OK - Natural Oak	ASC6.MC
Flintwood	F2SC6.D - Graphite	ASC6.FW
Natural Oak	F2SC6.OK - Natural Oak	ASC6.OK
Washed Oak	F2SC6.G - Silver	ASC6.WO
White	F2SC6.W - White	ASC6.W
Vetro		
Light Grey	F2SC6.G - Silver	VSC6.VG
White	F2SC6.G - Silver	VSC6.VW
Cinder	F2SC6.D - Graphite	VSC6.VC
Capella		
White	F2SC6.W - White	CSC6.W

Features

- Fascia to be cut on site to suit sanitaryware
- One adjustable shelf
- Soft close hinges
- Removable back panel
- For compatible basins see pages 122-123
- A plinth is required for this unit - see pages 112-113

Total £411.50

£257.00

£154.50



Exposed carcass sides are covered by using colour matched end panels which will be required to complete your fitted furniture run. See pages 112-113 for panel options.



Most freestanding units require a colour matched plinth to be installed to cover any pipework underneath the units. See pages 112-113 for plinth options.

SLIM DEPTH UNITS

700mm slim depth basin unit with fascia/door pack

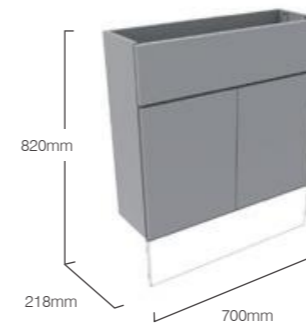

Finish	Recommended Carcass	Fascia/Door Pack
Burford		
Derwent Blue	F2SC7.D - Graphite	DSC7.DB
Mercury	F2SC7.D - Graphite	DSC7.MY
Chalk White	F2SC7.OK - Natural Oak	DSC7.CW
Mocha	F2SC7.OK - Natural Oak	DSC7.MC
Pebble Grey	F2SC7.OK - Natural Oak	DSC7.PG
Slate Grey	F2SC7.OK - Natural Oak	DSC7.SG
Aruba		
Derwent Blue	F2SC7.D - Graphite	ASC7.DB
Alpine Elm	F2SC7.G - Silver	ASC7.AE
Charcoal Elm	F2SC7.D - Graphite	ASC7.CE
Gloss Dark Clay	F2SC7.D - Graphite	ASC7.GDC
Mercury	F2SC7.D - Graphite	ASC7.MY
Mocha	F2SC7.OK - Natural Oak	ASC7.MC
Flintwood	F2SC7.D - Graphite	ASC7.FW
Natural Oak	F2SC7.OK - Natural Oak	ASC7.OK
Washed Oak	F2SC7.G - Silver	ASC7.WO
White	F2SC7.W - White	ASC7.W
Vetro		
Light Grey	F2SC7.G - Silver	VSC7.VG
White	F2SC7.G - Silver	VSC7.VW
Cinder	F2SC7.D - Graphite	VSC7.VC
Capella		
White	F2SC7.W - White	CSC7.W

Features

- Fascia to be cut on site to suit sanitaryware
- One adjustable shelf
- Soft close hinges
- Removable back panel
- For compatible basins see pages 122-123
- A plinth is required for this unit - see pages 112-113

Total £437.00

£266.00

£171.00

200mm slim depth floor cupboard with fascia/door pack

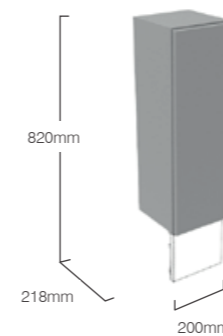

Burford		
Derwent Blue *	F2FC2.D - Graphite	DFC2.DB
Mercury *	F2FC2.D - Graphite	AFC2.MY
Chalk White *	F2FC2.OK - Natural Oak	DFC2.CW
Mocha *	F2FC2.OK - Natural Oak	DFC2.MC
Pebble Grey *	F2FC2.OK - Natural Oak	DFC2.PG
Slate Grey *	F2FC2.OK - Natural Oak	DFC2.SG
Aruba		
Derwent Blue	F2FC2.D - Graphite	AFC2.DB
Alpine Elm	F2FC2.G - Silver	AFC2.AE
Charcoal Elm	F2FC2.D - Graphite	AFC2.CE
Gloss Dark Clay	F2FC2.D - Graphite	AFC2.GDC
Mercury	F2FC2.D - Graphite	AFC2.MY
Mocha	F2FC2.OK - Natural Oak	DFC2.MC
Flintwood	F2FC2.D - Graphite	AFC2.FW
Natural Oak	F2FC2.OK - Natural Oak	AFC2.OK
Washed Oak	F2FC2.G - Silver	AFC2.WO
White	F2FC2.W - White	AFC2.W
Vetro		
Light Grey	F2FC2.G - Silver	VFC2.VG
White	F2FC2.G - Silver	VFC2.VW
Cinder	F2FC2.D - Graphite	VFC2.VC
Capella		
White	F2FC2.W - White	CFC2.W

Features

- Soft close hinges
- One adjustable shelf
- Reversible door
- A plinth is required for this unit - see pages 112-113

* These products have plain fronted fascia packs

Total £220.80

£169.50

£51.30



Exposed carcass sides are covered by using colour matched end panels which will be required to complete your fitted furniture run. See pages 111-112 for panel options.



Most freestanding units require a colour matched plinth to be installed to cover any pipework underneath the units. See pages 112-113 for plinth options.

SLIM DEPTH UNITS

300mm slim depth floor cupboard with fascia/door pack

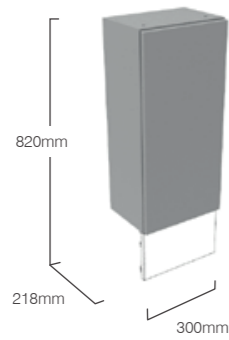

Finish	Recommended Carcass	Fascia/Door Pack
Burford		
Derwent Blue	F2FC3.D - Graphite	DFC3.DB
Mercury	F2FC3.D - Graphite	DFC3.MY
Chalk White	F2FC3.OK - Natural Oak	DFC3.CW
Mocha	F2FC3.OK - Natural Oak	DFC3.MC
Pebble Grey	F2FC3.OK - Natural Oak	DFC3.PG
Slate Grey	F2FC3.OK - Natural Oak	DFC3.SG
Aruba		
Derwent Blue	F2FC3.D - Graphite	AFC3.DB
Alpine Elm	F2FC3.G - Silver	AFC3.AE
Charcoal Elm	F2FC3.D - Graphite	AFC3.CE
Gloss Dark Clay	F2FC3.D - Graphite	AFC3.GDC
Mercury	F2FC3.D - Graphite	AFC3.MY
Mocha	F2FC3.OK - Natural Oak	AFC3.MC
Flintwood	F2FC3.D - Graphite	AFC3.FW
Natural Oak	F2FC3.OK - Natural Oak	AFC3.OK
Washed Oak	F2FC3.G - Silver	AFC3.WO
White	F2FC3.W - White	AFC3.W

- Features**
- Soft close hinges
 - One adjustable shelf
 - Reversible door
 - A plinth is required for this unit - see pages 112-113

Vetro		
Light Grey	F2FC3.G - Silver	VFC3.VG
White	F2FC3.G - Silver	VFC3.VW
Cinder	F2FC3.D - Graphite	VFC3.VC

Capella		
White	F2FC3.W - White	CFC3.W

Total £238.30 **£178.50** **£59.80**

400mm slim depth floor cupboard with fascia/door pack

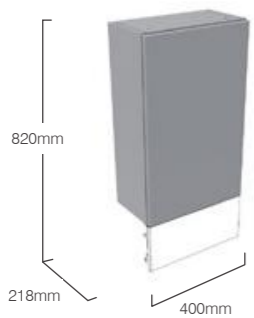

Burford		
Derwent Blue	F2FC4.D - Graphite	DFC4.DB
Mercury	F2FC4.D - Graphite	DFC4.MY
Chalk White	F2FC4.OK - Natural Oak	DFC4.CW
Mocha	F2FC4.OK - Natural Oak	DFC4.MC
Pebble Grey	F2FC4.OK - Natural Oak	DFC4.PG
Slate Grey	F2FC4.OK - Natural Oak	DFC4.SG
Aruba		
Derwent Blue	F2FC4.D - Graphite	AFC4.DB
Alpine Elm	F2FC4.G - Silver	AFC4.AE
Charcoal Elm	F2FC4.D - Graphite	AFC4.CE
Gloss Dark Clay	F2FC4.D - Graphite	AFC4.GDC
Mercury	F2FC4.D - Graphite	AFC4.MY
Mocha	F2FC4.OK - Natural Oak	AFC4.MC
Flintwood	F2FC4.D - Graphite	AFC4.FW
Natural Oak	F2FC4.OK - Natural Oak	AFC4.OK
Washed Oak	F2FC4.G - Silver	AFC4.WO
White	F2FC4.W - White	AFC4.W

- Features**
- Soft close hinges
 - One adjustable shelf
 - Reversible door
 - A plinth is required for this unit - see pages 112-113

Vetro		
Light Grey	F2FC4.G - Silver	VFC4.VG
White	F2FC4.G - Silver	VFC4.VW
Cinder	F2FC4.D - Graphite	VFC4.VC

Capella		
White	F2FC4.W - White	CFC4.W

Total £255.30 **£187.00** **£68.30**



Exposed carcass sides are covered by using colour matched end panels which will be required to complete your fitted furniture run. See pages 111-112 for panel options.



Most freestanding units require a colour matched plinth to be installed to cover any pipework underneath the units. See pages 112-113 for plinth options.

SLIM DEPTH UNITS

300mm slim depth shelf storage unit

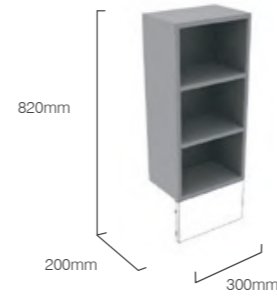

Features Recommended Carcass

- Can be cut down to suit odd size space in furniture run
- Supplied for self assembly
- A plinth is required for this unit - see pages 112-113

F2SS3.D - Graphite
F2SS3.OK - Natural Oak
F2SS3.W - White
F2SS3.G - Silver

Total £129.00 **£129.00**

200mm slim depth toilet roll holder cupboard with fascia/door pack

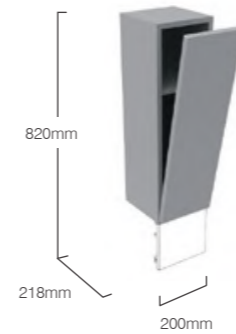

Finish Recommended Carcass Fascia/Door Pack

Burford		
Derwent Blue *	F2TR2.D - Graphite	DTR2.DB
Mercury *	F2TR2.D - Graphite	ATR2.MY
Chalk White *	F2TR2.OK - Natural Oak	DTR2.CW
Mocha *	F2TR2.OK - Natural Oak	DTR2.MC
Pebble Grey *	F2TR2.OK - Natural Oak	DTR2.PG
Slate Grey *	F2TR2.OK - Natural Oak	DTR2.SG

Aruba		
Derwent Blue	F2TR2.D - Graphite	ATR2.DB
Alpine Elm	F2TR2.G - Silver	ATR2.AE
Charcoal Elm	F2TR2.D - Graphite	ATR2.CE
Gloss Dark Clay	F2TR2.D - Graphite	ATR2.GDC
Mercury	F2TR2.D - Graphite	ATR2.MY
Mocha	F2TR2.OK - Natural Oak	DTR2.MC
Flintwood	F2TR2.D - Graphite	ATR2.FW
Natural Oak	F2TR2.OK - Natural Oak	ATR2.OK
Washed Oak	F2TR2.G - Silver	ATR2.WO
White	F2TR2.W - White	ATR2.W

Vetro		
Light Grey	F2TR2.G - Silver	VTR2.VG
White	F2TR2.G - Silver	VTR2.VW
Cinder	F2TR2.D - Graphite	VTR2.VC

Capella		
White	F2TR2.W - White	CTR2.W

Total £317.30 **£266.00** **£51.30**

- Features**
- Pull down door
 - Toilet roll stored on back of door
 - A plinth is required for this unit - see pages 112-113

* These products have plain fronted fascia packs



Exposed carcass sides are covered by using colour matched end panels which will be required to complete your fitted furniture run. See pages 111-112 for panel options.



Most freestanding units require a colour matched plinth to be installed to cover any pipework underneath the units. See pages 112-113 for plinth options.

SLIM DEPTH UNITS

300mm slim depth full height twin door cupboard with fascia/door pack

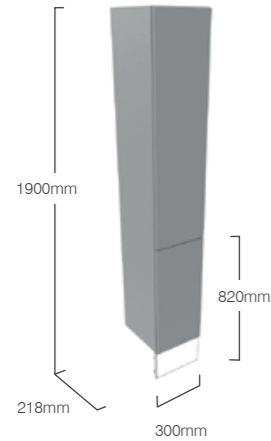

Burford

Derwent Blue
Mercury
Chalk White
Mocha
Pebble Grey
Slate Grey

F2FHU3.D - Graphite
F2FHU3.D - Graphite
F2FHU3.OK - Natural Oak
F2FHU3.OK - Natural Oak
F2FHU3.OK - Natural Oak
F2FHU3.OK - Natural Oak

DFHU3.DB
DFHU3.MY
DFHU3.CW
DFHU3.MC
DFHU3.PG
DFHU3.SG

Aruba

Derwent Blue
Alpine Elm
Charcoal Elm
Gloss Dark Clay
Mercury
Mocha
Flintwood
Natural Oak
Washed Oak
White

F2FHU3.D - Graphite
F2FHU3.G - Silver
F2FHU3.D - Graphite
F2FHU3.D - Graphite
F2FHU3.D - Graphite
F2FHU3.OK - Natural Oak
F2FHU3.D - Graphite
F2FHU3.OK - Natural Oak
F2FHU3.G - Silver
F2FHU3.W - White

AFHU3.DB
AFHU3.AE
AFHU3.CE
AFHU3.GDC
AFHU3.MY
AFHU3.MC
AFHU3.FW
AFHU3.OK
AFHU3.WO
AFHU3.W

Vetro

Light Grey
White
Cinder

F2FHU3.G - Silver
F2FHU3.G - Silver
F2FHU3.D - Graphite

VFHU3.VG
VFHU3.VW
VFHU3.VC

Capella

White

F2FHU3.W - White

CFHU3.W

Features

- Soft close hinges
- Two adjustable glass shelves in top section
- One wooden adjustable shelf in base
- A plinth is required for this unit - see pages 112-113

Total £468.00

£339.00

£129.00



Exposed carcass sides are covered by using colour matched end panels which will be required to complete your fitted furniture run. See pages 111-112 for panel options.



Most freestanding units require a colour matched plinth to be installed to cover any pipework underneath the units. See pages 112-113 for plinth options.

WALL CUPBOARDS - SUITABLE FOR STANDARD & SLIM DEPTH UNITS

200mm wall mounted cupboard with fascia/door pack

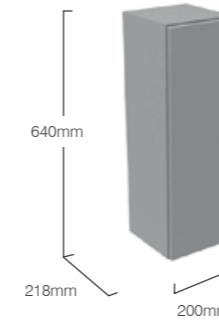

Features

- Soft close hinges
- Reversible door
- Two glass shelves
- Concealed hangers

* These products have plain fronted fascia packs

Total £213.80

Finish

Burford

Derwent Blue *
Mercury *
Chalk White *
Mocha *
Pebble Grey *
Slate Grey *

Aruba

Derwent Blue
Alpine Elm
Charcoal Elm
Gloss Dark Clay
Mercury
Mocha
Flintwood
Natural Oak
Washed Oak
White

Vetro

Light Grey
White
Cinder

Capella

White

Recommended Carcass

F2WC2.D - Graphite
F2WC2.D - Graphite
F2WC2.OK - Natural Oak
F2WC2.OK - Natural Oak
F2WC2.OK - Natural Oak
F2WC2.OK - Natural Oak

F2WC2.D - Graphite
F2WC2.G - Silver
F2WC2.D - Graphite
F2WC2.D - Graphite
F2WC2.D - Graphite
F2WC2.D - Graphite
F2WC2.OK - Natural Oak
F2WC2.D - Graphite
F2WC2.OK - Natural Oak
F2WC2.G - Silver
F2WC2.W - White

F2WC2.G - Silver
F2WC2.G - Silver
F2WC2.D - Graphite

F2WC2.W - White

Fascia/Door Pack

DFC2.DB
AFC2.MY
DFC2.CW
DFC2.MC
DFC2.PG
DFC2.SG

AFC2.DB
AFC2.AE
AFC2.CE
AFC2.GDC
AFC2.MY
DFC2.MC
AFC2.FW
AFC2.OK
AFC2.WO
AFC2.W

VFC2.VG
VFC2.VW
VFC2.VC

CFC2.W

£162.50

£51.30

300mm wall mounted cupboard

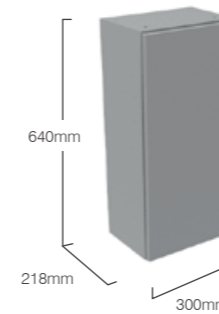

Features

- Soft close hinges
- Reversible door
- Two glass shelves
- Concealed hangers

Burford

Derwent Blue
Mercury
Chalk White
Mocha
Pebble Grey
Slate Grey

Aruba

Derwent Blue
Alpine Elm
Charcoal Elm
Gloss Dark Clay
Mercury
Mocha
Flintwood
Natural Oak
Washed Oak
White

Vetro

Light Grey
White
Cinder

Capella

White

F2WC3.D - Graphite
F2WC3.D - Graphite
F2WC3.OK - Natural Oak
F2WC3.OK - Natural Oak
F2WC3.OK - Natural Oak
F2WC3.OK - Natural Oak

F2WC3.D - Graphite
F2WC3.G - Silver
F2WC3.D - Graphite
F2WC3.D - Graphite
F2WC3.D - Graphite
F2WC3.OK - Natural Oak
F2WC3.D - Graphite
F2WC3.OK - Natural Oak
F2WC3.G - Silver
F2WC3.W - White

F2WC3.G - Silver
F2WC3.G - Silver
F2WC3.D - Graphite

F2WC3.W - White

DFC3.DB
DFC3.MY
DFC3.CW
DFC3.MC
DFC3.PG
DFC3.SG

AFC3.DB
AFC3.AE
AFC3.CE
AFC3.GDC
AFC3.MY
AFC3.MC
AFC3.FW
AFC3.OK
AFC3.WO
AFC3.W

VFC3.VG
VFC3.VW
VFC3.VC

CFC3.W

Total £240.30

£180.50

£59.80

WALL CUPBOARDS - SUITABLE FOR STANDARD & SLIM DEPTH UNITS

400mm wall mounted cupboard with fascia/door pack

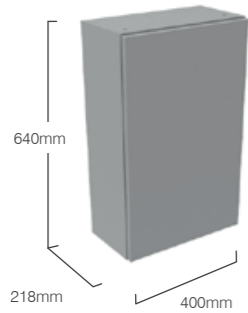

Finish	Recommended Carcass	Fascia/Door Pack
Burford		
Derwent Blue	F2WC4.D - Graphite	DFC4.DB
Mercury	F2WC4.D - Graphite	DFC4.MY
Chalk White	F2WC4.OK - Natural Oak	DFC4.CW
Mocha	F2WC4.OK - Natural Oak	DFC4.MC
Pebble Grey	F2WC4.OK - Natural Oak	DFC4.PG
Slate Grey	F2WC4.OK - Natural Oak	DFC4.SG
Aruba		
Derwent Blue	F2WC4.D - Graphite	AFC4.DB
Alpine Elm	F2WC4.G - Silver	AFC4.AE
Charcoal Elm	F2WC4.D - Graphite	AFC4.CE
Gloss Dark Clay	F2WC4.D - Graphite	AFC4.GDC
Mercury	F2WC4.D - Graphite	AFC4.MY
Mocha	F2WC4.OK - Natural Oak	AFC4.MC
Flintwood	F2WC4.D - Graphite	AFC4.FW
Natural Oak	F2WC4.OK - Natural Oak	AFC4.OK
Washed Oak	F2WC4.G - Silver	AFC4.WO
White	F2WC4.W - White	AFC4.W
Vetro		
Light Grey	F2WC4.G - Silver	VFC4.VG
White	F2WC4.G - Silver	VFC4.VW
Cinder	F2WC4.D - Graphite	VFC4.VC
Capella		
White	F2WC4.W - White	CFC4.W

Features

- Soft close hinges
- Reversible door
- Two glass shelves
- Concealed hangers

Total £265.30

£197.00

£68.30

600mm wall mounted cupboard with fascia/door pack

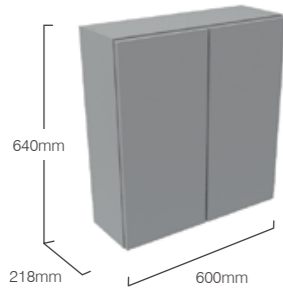

Finish	Recommended Carcass	Fascia/Door Pack
Burford		
Derwent Blue	F2WC6.D - Graphite	DFC3.DB x2
Mercury	F2WC6.D - Graphite	DFC3.MY x2
Chalk White	F2WC6.OK - Natural Oak	DFC3.CW x2
Mocha	F2WC6.OK - Natural Oak	DFC3.MC x2
Pebble Grey	F2WC6.OK - Natural Oak	DFC3.PG x2
Slate Grey	F2WC6.OK - Natural Oak	DFC3.SG x2
Aruba		
Derwent Blue	F2WC6.D - Graphite	AFC3.DB x2
Alpine Elm	F2WC6.G - Silver	AFC3.AE x2
Charcoal Elm	F2WC6.D - Graphite	AFC3.CE x2
Gloss Dark Clay	F2WC6.D - Graphite	AFC3.GDC x2
Mercury	F2WC6.D - Graphite	AFC3.MY x2
Mocha	F2WC6.OK - Natural Oak	AFC3.MC x2
Flintwood	F2WC6.D - Graphite	AFC3.FW x2
Natural Oak	F2WC6.OK - Natural Oak	AFC3.OK x2
Washed Oak	F2WC6.G - Silver	AFC3.WO x2
White	F2WC6.W - White	AFC3.W x2
Vetro		
Light Grey	F2WC6.G - Silver	VFC3.VG x2
White	F2WC6.G - Silver	VFC3.VW x2
Cinder	F2WC6.D - Graphite	VFC3.VC x2
Capella		
White	F2WC6.W - White	CFC3.W x2

Features

- Soft close hinges
- Two glass shelves
- Concealed hangers

Total £370.60

£251.00

£119.60



HANDLES

	Finish	Code	Price
	Kansas handle		
	• 197mm(l)	Chrome	FHKAN20.C £14.60
	• 247mm(l)	Chrome	FHKAN25.C £16.90
	• 297mm(l)	Chrome	FHKAN30.C £19.30
	• 347mm(l)	Chrome	FHKAN35.C £21.70
	• 397mm(l)	Chrome	FHKAN40.C £24.30
• 552mm(l)	Chrome	FHKAN55.C £28.10	
• 752mm(l)	Chrome	FHKAN75.C £32.80	
	Stockton handle		
	• 128mm(l)	Chrome	SCHH04C.128 £14.90
	• 320mm(l)	Chrome	SCHH04C.320 £19.30
• 492mm(l)	Chrome	SCHH04C.492 £31.40	
	Stockton handle		
	• 128mm(l)	Black	SCHH04B.128 £14.90
	• 320mm(l)	Black	SCHH04B.320 £19.30
• 492mm(l)	Black	SCHH04B.492 £31.40	
	Stockton handle		
	• 128mm(l)	Brass	SCHH04A.128 £14.90
	• 320mm(l)	Brass	SCHH04A.320 £19.30
• 492mm(l)	Brass	SCHH04A.492 £31.40	
	Columbus Handle		
• Angular classic handle	Chrome	FHCOL.C £19.00	
• Length 174mm			
• Hole centres 160mm			
	Oakland handle		
• Classic or contemporary handle	Chrome	FHOAK.C £19.00	
• Length 183mm			
• Hole centres 160mm			
	Madison handle		
• Length 171mm	Chrome	FHMAD.C £19.00	
• Hole centres 160mm			
	Montana handle		
• Length 110mm	Chrome	FHMON.C £7.50	
• Hole centres 64mm			
	Vermont handle		
• Square	Chrome	FHVER.C £14.90	
• D-shaped handle			
• Length 135mm			
• Hole centres 128mm			
	Seattle handle		
• D-shaped handle	Chrome	FHSEA.C £19.00	
• Length 175mm			
• Hole centres 160mm			
	Detroit handle		
• Rubberised grip to handle	Chrome	FHDET.C £19.00	
• Length 187mm			
• Hole centres 160mm			
	Daytona handle		
• Black insert detail	Chrome	FHDAY.C £19.00	
• Length 170mm			
• Hole centres 160mm			

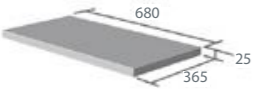

	Finish	Code	Price
	Utah handle		
• Square design	Chrome	FHUTA.C £19.00	
• 75mm x 75mm			
• Hole centres 64mm			
	Lexington handle		
• Crystal effect inserts x 30	Chrome	FHLEX.C £27.10	
• Length 134mm			
• Hole centres 128mm			
	Henderson handle		
• Classic round knob	Chrome	FHHEN.C £7.80	
• Diameter 39mm			
• Height 26mm			
	Reno handle		
• Classic timeless knob	Chrome	FHREN.C £14.90	
• Diameter 32mm			
• Height 29mm			
	Washington handle		
• Chrome button knob	Chrome	FHWAS.C £7.80	
• Height 22mm			
	Washington handle		
• Brass button knob	Brass	FHWAS.A £7.80	
• Height 22mm			
	Carolina handle		
• Square cushion knob	Chrome	FHCAR.C £6.30	
• Height 15mm			
	Indiana handle		
• Round head knob	Chrome	FHIND.C £7.50	
• Height 20mm			
	Portland handle		
• Length 32mm	Chrome	FHPORC.32 £7.80	
• Length 160mm	Chrome	FHPORC.160 £19.00	
	Portland handle		
• Length 32mm	Brass	FHPORA.32 £7.80	
• Length 160mm	Brass	FHPORA.160 £19.00	

WORKTOPS - STRATA SOLID SURFACE

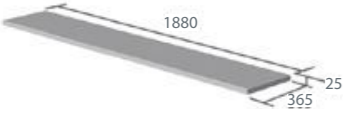
Strata Solid Surface Worktops - Standard Depth

	Finish	Code	Price
 <p>680mm standard depth solid surface worktop</p> <ul style="list-style-type: none"> Can be cut to any size/shape Supplied with front and ends factory finished 3mm edge profile 	Carrara Arctic White Stone Grey Ice White Starlight Jurassic Copper Galactic Black Glacier White Grey Quartz	F3W6A.CA F3W6A.AR F3W6A.SG F3W6A.IW F3W6A.SL F3W6A.JU F3W6A.CP F3W6A.GA F3W6A.GL F3W6A.GQ	£186.00
 <p>1280mm standard depth solid surface worktop</p> <ul style="list-style-type: none"> Can be cut to any size/shape Supplied with front and ends factory finished 3mm edge profile 	Carrara Arctic White Stone Grey Ice White Starlight Jurassic Copper Galactic Black Glacier White Grey Quartz	F3W12A.CA F3W12A.AR F3W12A.SG F3W12A.IW F3W12A.SL F3W12A.JU F3W12A.CP F3W12A.GA F3W12A.GL F3W12A.GQ	£336.00
 <p>1880mm standard depth solid surface worktop</p> <ul style="list-style-type: none"> Can be cut to any size/shape Supplied with front and ends factory finished 3mm edge profile 	Carrara Arctic White Stone Grey Ice White Starlight Jurassic Copper Galactic Black Glacier White Grey Quartz	F3W18A.CA F3W18A.AR F3W18A.SG F3W18A.IW F3W18A.SL F3W18A.JU F3W18A.CP F3W18A.GA F3W18A.GL F3W18A.GQ	£427.00

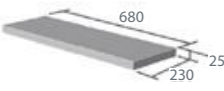
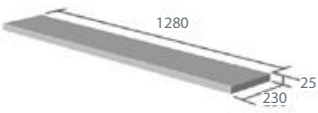
Strata Solid Surface Worktops - Slim Depth

 <p>680mm slim depth solid surface worktop</p> <ul style="list-style-type: none"> Can be cut to any size/shape Supplied with front and ends factory finished 3mm edge profile 	Carrara Arctic White Stone Grey Ice White Starlight Jurassic Copper Galactic Black Glacier White Grey Quartz	F2W6A.CA F2W6A.AR F2W6A.SG F2W6A.IW F2W6A.SL F2W6A.JU F2W6A.CP F2W6A.GA F2W6A.GL F2W6A.GQ	£142.00
 <p>1280mm slim depth solid surface worktop</p> <ul style="list-style-type: none"> Can be cut to any size/shape Supplied with front and ends factory finished 3mm edge profile 	Carrara Arctic White Stone Grey Ice White Starlight Jurassic Copper Galactic Black Glacier White Grey Quartz	F2W12A.CA F2W12A.AR F2W12A.SG F2W12A.IW F2W12A.SL F2W12A.JU F2W12A.CP F2W12A.GA F2W12A.GL F2W12A.GQ	£235.50
 <p>1880mm slim depth solid surface worktop</p> <ul style="list-style-type: none"> Can be cut to any size/shape Supplied with front and ends factory finished 3mm edge profile 	Carrara Arctic White Stone Grey Ice White Starlight Jurassic Copper Galactic Black Glacier White Grey Quartz	F2W18A.CA F2W18A.AR F2W18A.SG F2W18A.IW F2W18A.SL F2W18A.JU F2W18A.CP F2W18A.GA F2W18A.GL F2W18A.GQ	£342.00

Strata Solid Surface Worktop Adhesive

 <p>Strata 2 part glue cartridge and nozzle</p> <ul style="list-style-type: none"> 2 part adhesive for Strata tops Supplied with applicator - no need for specialist adhesive gun 	Clear	FSG.CL	£40.40
--	-------	--------	--------

BASINS WITH INTEGRATED WORKTOPS

City Solid Surface Basin & Integrated Worktop

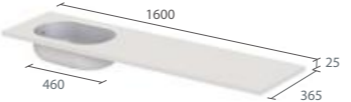
	Finish	Code	Price
 <p>1600mm solid surface worktop with integrated basin</p> <ul style="list-style-type: none"> To be used with 600mm semi-countertop units only Solid surface basin can be used left or right handed Can be cut to any length to suit furniture Undrilled to allow choice of tap position Integral overflow 	Arctic White	C3WTBAS	£610.00

Motif Solid Surface Basin & Integrated Worktop

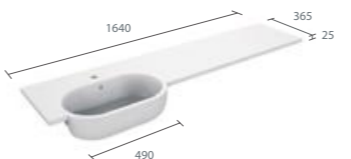
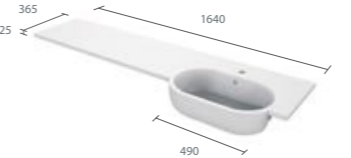
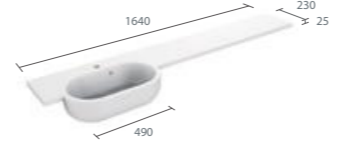
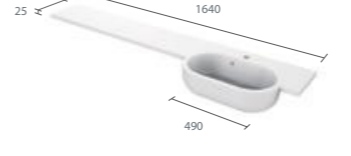
 <p>1640mm standard depth left hand basin</p> <ul style="list-style-type: none"> To be used with standard 600mm semi-countertop units only Solid surface basin Can be cut to any length to suit furniture Undrilled to allow choice of tap position Integral overflow 	Arctic White	MTF3BAS.L	£674.00
 <p>1640mm standard depth right hand basin</p> <ul style="list-style-type: none"> To be used with standard 600mm semi-countertop units only Solid surface basin Can be cut to any length to suit furniture Undrilled to allow choice of tap position Integral overflow 	Arctic White	MTF3BAS.R	£674.00
 <p>1640mm slim depth left hand basin</p> <ul style="list-style-type: none"> To be used with slim 600mm semi-countertop units only Solid surface basin Can be cut to any length to suit furniture Undrilled to allow choice of tap position Integral overflow 	Arctic White	MTF2BAS.L	£539.00
 <p>1640mm slim depth right hand basin</p> <ul style="list-style-type: none"> To be used with slim 600mm semi-countertop units only Solid surface basin Can be cut to any length to suit furniture Undrilled to allow choice of tap position Integral overflow 	Arctic White	MTF2BAS.R	£539.00

WORKTOPS - LAMINATE

Laminate Worktops - Standard Depth

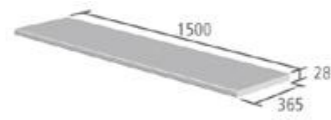

- 1500mm standard depth**
- 28mm thickness with a 6mm edge radius
 - Edge banded both ends and supplied with extra edge banding to use when cut down
 - Sealed under front profile to prevent water ingress

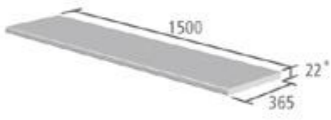

- 1500mm standard depth soft touch ***
- Soft touch, super-matt finish. Will not show fingerprints
 - Contemporary slim profile
 - 22mm thickness with a 4mm edge radius
 - Edge banded both ends and supplied with extra edge banding to use when cut down
 - Sealed under front profile to prevent water ingress

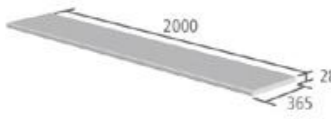

- 2000mm standard depth**
- 28mm thickness with a 6mm edge radius
 - Edge banded both ends and supplied with extra edge banding to use when cut down
 - Sealed under front profile to prevent water ingress

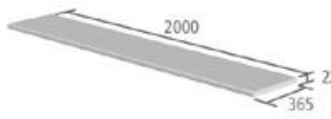

- 2000mm standard depth soft touch ***
- Soft touch, super-matt finish. Will not show fingerprints
 - Contemporary slim profile
 - 22mm thickness with a 4mm edge radius
 - Edge banded both ends and supplied with extra edge banding to use when cut down
 - Sealed under front profile to prevent water ingress

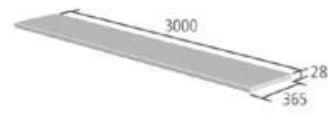

- 3000mm standard depth laminate worktop**
- 28mm thickness with a 6mm edge radius
 - Edge banded both ends and supplied with extra edge banding to use when cut down
 - Sealed under front profile to prevent water ingress
 - 3m length laminates may be supplied via separate delivery

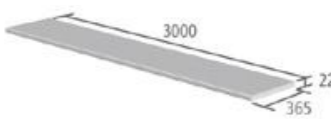

- 3000mm standard depth soft touch laminate worktop ***
- Soft touch, super-matt finish. Will not show fingerprints
 - Contemporary slim profile
 - 22mm thickness with a 4mm edge radius
 - Edge banded both ends and supplied with extra edge banding to use when cut down
 - Sealed under front profile to prevent water ingress
 - 3m length laminates may be supplied via separate delivery

Laminate Worktops - Slim Depth

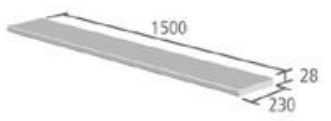

- 1500mm slim depth laminate worktop**
- 28mm thickness with a 6mm edge radius
 - Edge banded both ends and supplied with extra edge banding to use when cut down
 - Sealed under front profile to prevent water ingress

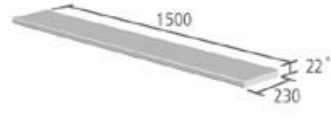

- 1500mm slim depth soft touch laminate worktop ***
- Soft touch, super-matt finish. Will not show fingerprints
 - Contemporary slim profile
 - 22mm thickness with a 4mm edge radius
 - Edge banded both ends and supplied with extra edge banding to use when cut down
 - Sealed under front profile to prevent water ingress

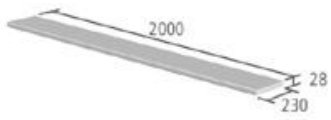

- 2000mm slim depth laminate worktop**
- 28mm thickness with a 6mm edge radius
 - Edge banded both ends and supplied with extra edge banding to use when cut down
 - Sealed under front profile to prevent water ingress

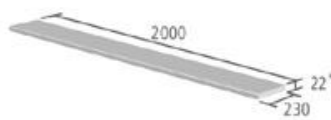

- 2000mm slim depth soft touch laminate worktop ***
- Soft touch, super-matt finish. Will not show fingerprints
 - Contemporary slim profile
 - 22mm thickness with a 4mm edge radius
 - Edge banded both ends and supplied with extra edge banding to use when cut down
 - Sealed under front profile to prevent water ingress

Massa Marble	F3W15.MM	£107.00
Grey Marble	F3W15.GM	£107.00
Portland Stone	F3W15.PS	£107.00
White Sparkle	F3W15.WS	£117.50
Black Sparkle	F3W15.BS	£117.50
Gloss White	F3W15.W	£107.00
Black Granite	F3W15.BG	£107.00
Riven Slate	F3W15.SL	£107.00
Isadora Stone	F3W15.IS	£107.00
Natural Oak	F3W15.OK	£107.00

Smoke	F3W15ST.SK *	£144.50
Shale	F3W15ST.SH *	£144.50

Massa Marble	F3W20.MM	£132.50
Grey Marble	F3W20.GM	£132.50
Portland Stone	F3W20.PS	£132.50
White Sparkle	F3W20.WS	£145.50
Black Sparkle	F3W20.BS	£145.50
Gloss White	F3W20.W	£132.50
Black Granite	F3W20.BG	£132.50
Riven Slate	F3W20.SL	£132.50
Isadora Stone	F3W20.IS	£132.50
Natural Oak	F3W20.OK	£132.50

Smoke	F3W20ST.SK *	£175.50
Shale	F3W20ST.SH *	£175.50

Massa Marble	F3W30.MM	£267.00
Grey Marble	F3W30.GM	£267.00
Portland Stone	F3W30.PS	£267.00
White Sparkle	F3W30.WS	£284.00
Black Sparkle	F3W30.BS	£284.00
Gloss White	F3W30.W	£267.00
Black Granite	F3W30.BG	£267.00
Riven Slate	F3W30.SL	£267.00
Isadora Stone	F3W30.IS	£267.00
Natural Oak	F3W30.OK	£267.00

Smoke	F3W30ST.SK *	£340.00
Shale	F3W30ST.SH *	£340.00

Massa Marble	F2W15.MM	£90.10
Grey Marble	F2W15.GM	£90.10
Portland Stone	F2W15.PS	£90.10
White Sparkle	F2W15.WS	£99.10
Black Sparkle	F2W15.BS	£99.10
Gloss White	F2W15.W	£90.10
Black Granite	F2W15.BG	£90.10
Riven Slate	F2W15.SL	£90.10
Isadora Stone	F2W15.IS	£90.10
Natural Oak	F2W15.OK	£90.10

Smoke	F2W15ST.SK *	£118.50
Shale	F2W15ST.SH *	£118.50

Massa Marble	F2W20.MM	£115.00
Grey Marble	F2W20.GM	£115.00
Portland Stone	F2W20.PS	£115.00
White Sparkle	F2W20.WS	£127.00
Black Sparkle	F2W20.BS	£127.00
Gloss White	F2W20.W	£115.00
Black Granite	F2W20.BG	£115.00
Riven Slate	F2W20.SL	£115.00
Isadora Stone	F2W20.IS	£115.00
Natural Oak	F2W20.OK	£115.00

Smoke	F2W20ST.SK *	£154.50
Shale	F2W20ST.SH *	£154.50

PANELS & PLINTHS

Standard Panels



18mm Standard filler/clad-on end panel

- Fully edged
- Can be cut to suit different installations
- Use for colour matched end panels

* Burford end panels have feature tongue & groove effect



18mm Tall standard filler/clad-on end panel

- Fully edged
- Can be cut to suit different installations
- Use for colour matched end panels

* Burford end panels have feature tongue & groove effect



30mm clad on end panel standard

- Clad on to units to create striking effects
- Allows creation of a framed inset door look. If desired these panels can be cut in half and used between carcass units in a run to create this framed look instead of using a full panel each time
- Use with standard depth base units
- Cut down for wall-hung base unit installations

* Burford end panels have feature tongue & groove effect

Slim Depth Panels



18mm slim depth filler/clad-on end panel

- Fully edged
- Can be cut to suit different installations
- Use for colour matched end panels

* Burford end panels have feature tongue & groove effect

Finish	Code	Price
Aruba Derwent Blue	F3P8.DB	£66.10
Aruba Alpine Elm	F3P8.AE	£66.10
Aruba Charcoal Elm	F3P8.CE	£66.10
Aruba Gloss Dark Clay	F3P8.GDC	£79.10
Aruba Flintwood	F3P8.FW	£66.10
Aruba Natural Oak	F3P8.OK	£66.10
Aruba Washed Oak	F3P8.WO	£66.10
Aruba Mercury	AF3P8.MY	£66.10
Aruba Mocha	AF3P8.MC	£66.10
Vetro White	F3P8.VW	£66.10
Vetro Cinder	F3P8.VC	£66.10
Vetro Light Grey	F3P8.VG	£66.10
Burford Derwent Blue *	DF3P8.DB	£79.10
Burford Mercury *	DF3P8.MY	£79.10
Burford Chalk White *	F3P8.CW	£79.10
Burford Mocha *	F3P8.MC	£79.10
Burford Pebble Grey *	F3P8.PG	£79.10
Burford Slate Grey *	F3P8.SG	£79.10
White	F3P8.W	£66.10

Aruba Derwent Blue	F3TP19.DB	£142.00
Aruba Alpine Elm	F3TP19.AE	£142.00
Aruba Charcoal Elm	F3TP19.CE	£142.00
Aruba Gloss Dark Clay	F3TP19.GDC	£142.00
Aruba Flintwood	F3TP19.FW	£113.50
Aruba Natural Oak	F3TP19.OK	£113.50
Aruba Washed Oak	F3TP19.WO	£113.50
Aruba Mercury	AF3TP19.MY	£113.50
Aruba Mocha	AF3TP19.MC	£113.50
Vetro White	F3TP19.VW	£113.50
Vetro Cinder	F3TP19.VC	£113.50
Vetro Grey	F3TP19.VG	£113.50
Burford Derwent Blue *	DF3TP19.DB	£142.00
Burford Mercury *	DF3TP19.MY	£142.00
Burford Chalk White *	F3TP19.CW	£142.00
Burford Mocha *	F3TP19.MC	£142.00
Burford Pebble Grey *	F3TP19.PG	£142.00
Burford Slate Grey *	F3TP19.SG	£142.00
White	F3TP19.W	£113.50

Aruba Derwent Blue	F3APDB	£113.00
Aruba Alpine Elm	F3APAE	£113.00
Aruba Charcoal Elm	F3APCE	£113.00
Aruba Gloss Dark Clay	F3APGDC	£113.00
Aruba Flintwood	F3APFW	£93.90
Aruba Natural Oak	F3APOK	£93.90
Aruba Washed Oak	F3APWO	£93.90
Aruba Mercury	AF3APMY	£93.90
Aruba Mocha	AF3APMC	£93.90
Vetro White	F3APVW	£93.90
Vetro Cinder	F3APVC	£93.90
Vetro Grey	F3APVG	£93.90
Burford Derwent Blue *	DF3APDB	£113.00
Burford Mercury *	DF3APMY	£113.00
Burford Chalk White *	F3APCW	£113.00
Burford Mocha *	F3APMC	£113.00
Burford Pebble Grey *	F3APPG	£113.00
Burford Slate Grey *	F3APSG	£113.00
White	F3APW	£93.90

Aruba Derwent Blue	F2P8.DB	£67.80
Aruba Alpine Elm	F2P8.AE	£67.80
Aruba Charcoal Elm	F2P8.CE	£67.80
Aruba Gloss Dark Clay	F2P8.GDC	£67.80
Aruba Flintwood	F2P8.FW	£56.50
Aruba Natural Oak	F2P8.OK	£56.50
Aruba Washed Oak	F2P8.WO	£56.50
Aruba Mercury	AF2P8.MY	£56.50
Aruba Mocha	AF2P8.MC	£56.50
Vetro White	F2P8.VW	£56.50
Vetro Cinder	F2P8.VC	£56.50
Vetro Grey	F2P8.VG	£56.50
Burford Derwent Blue *	DF2P8.DB	£67.80
Burford Mercury *	DF2P8.MY	£67.80
Burford Chalk White *	F2P8.CW	£67.80
Burford Mocha *	F2P8.MC	£67.80
Burford Pebble Grey *	F2P8.PG	£67.80
Burford Slate Grey *	F2P8.SG	£67.80
White	F2P8.W	£56.50

PANELS & PLINTHS

Slim Depth Panels

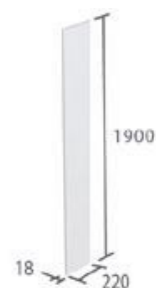

18mm Tall slim filler/clad-on end panel

- Fully edged
- Can be cut to suit different installations
- Use for colour matched end panels

Finish	Code	Price
Aruba Derwent Blue	F2TP19.DB	£103.00
Aruba Alpine Elm	F2TP19.AE	£103.00
Aruba Charcoal Elm	F2TP19.CE	£103.00
Aruba Gloss Dark Clay	AF2TP19.GDC	£136.00
Aruba Flintwood	F2TP19.FW	£103.00
Aruba Natural Oak	F2TP19.OK	£103.00
Aruba Washed Oak	F2TP19.WO	£103.00
Aruba Mercury	AF2TP19.MY	£136.00
Aruba Mocha	AF2TP19.MC	£136.00
Vetro White	F2TP19.VW	£103.00
Vetro Cinder	F2TP19.VC	£103.00
Vetro Grey	F2TP19.VG	£103.00
Burford Derwent Blue *	DF2TP19.DB	£136.00
Burford Mercury *	DF2TP19.MY	£136.00
Burford Chalk White *	F2TP19.CW	£136.00
Burford Mocha *	F2TP19.MC	£136.00
Burford Pebble Grey *	F2TP19.PG	£136.00
Burford Slate Grey *	F2TP19.SG	£136.00
White	F2TP19.W	£136.00

Slim Depth Panels

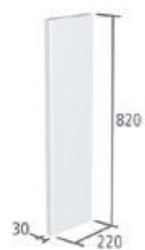

30mm slim depth clad on end panel

- Clad on to units to create striking effects
- Allows creation of a framed inset door look. If desired these panels can be cut in half and used between carcass units in a run to create this framed look instead of using a full panel each time
- Use with standard depth base units
- Cut down for wall-hung base unit installations

* Burford end panels have feature tongue & groove effect

Finish	Code	Price
Aruba Derwent Blue	F2APDB	£68.30
Aruba Alpine Elm	F2APAE	£81.80
Aruba Charcoal Elm	F2APCE	£81.80
Aruba Gloss Dark Clay	F2APGDC	£81.80
Aruba Flintwood	F2APFW	£68.30
Aruba Natural Oak	F2APOK	£68.30
Aruba Washed Oak	F2APWO	£68.30
Aruba Mercury	AF2APMY	£68.30
Aruba Mocha	AF2APMC	£68.30
Vetro White	F2APVW	£68.30
Vetro Cinder	F2APVC	£68.30
Vetro Grey	F2APVG	£68.30
Burford Derwent Blue *	DF2APDB	£81.80
Burford Mercury *	DF2APMY	£81.80
Burford Chalk White *	F2APCW	£81.80
Burford Mocha *	F2APMC	£81.80
Burford Pebble Grey *	F2APPG	£81.80
Burford Slate Grey *	F2APSG	£81.80
White	F2APW	£68.30

Plinths & Cornices

1500mm plinth

- 1500mm length - cut to size
- Fully edged

* Burford plinths have an added feature rail



Finish	Code	Price
Aruba Derwent Blue	FPL15.DB	£85.40
Aruba Alpine Elm	FPL15.AE	£85.40
Aruba Charcoal Elm	FPL15.CE	£85.40
Aruba Gloss Dark Clay	FPL15.GDC	£115.50
Aruba Flintwood	FPL15.FW	£68.30
Aruba Natural Oak	FPL15.OK	£68.30
Aruba Washed Oak	FPL15.WO	£68.30
Aruba Mercury	AFPL15.MY	£68.30
Aruba Mocha	AFPL15.MC	£68.30
Vetro White	FPL15.VW	£85.40
Vetro Cinder	FPL15.VC	£85.40
Vetro Grey	FPL15.VG	£85.40
Burford Derwent Blue *	DFPL15.DB	£102.50
Burford Mercury *	DFPL15.MY	£102.50
Burford Chalk White *	FPL15.CW	£102.50
Burford Mocha *	FPL15.MC	£102.50
Burford Pebble Grey *	FPL15.PG	£102.50
Burford Slate Grey *	FPL15.SG	£102.50
White	FPL15.W	£68.30

2000mm plinth

- 2000mm length - cut to size
- Fully edged

* Burford plinths have an added feature rail



Finish	Code	Price
Aruba Derwent Blue	FPL20.DB	£96.00
Aruba Alpine Elm	FPL20.AE	£96.00
Aruba Charcoal Elm	FPL20.CE	£96.00
Aruba Gloss Dark Clay	FPL20.GDC	£115.50
Aruba Flintwood	FPL20.FW	£76.90
Aruba Natural Oak	FPL20.OK	£76.90
Aruba Washed Oak	FPL20.WO	£76.90
Aruba Mercury	AFPL20.MY	£76.90
Aruba Mocha	AFPL20.MC	£76.90
Vetro White	FPL20.VW	£96.00
Vetro Cinder	FPL20.VC	£96.00
Vetro Grey	FPL20.VG	£96.00
Burford Derwent Blue *	DFPL20.DB	£115.50
Burford Mercury *	DFPL20.MY	£115.50
Burford Chalk White *	FPL20.CW	£115.50
Burford Mocha *	FPL20.MC	£115.50
Burford Pebble Grey *	FPL20.PG	£115.50
Burford Slate Grey *	FPL20.SG	£115.50
White	FPL20.W	£76.90

BATH PANELS

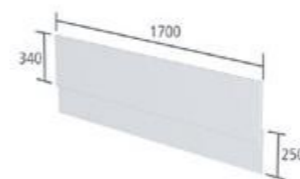

1700mm bath panel with plinth

- Nominal height from underside of bath to floor 520mm, this gives plinth height of 180mm to match furniture
- Plinth can be screwed to panel from rear
- Maximum height 570mm
- Styles vary according to range

Finish	Code	Price
Derwent Blue	FBP17.DB	£244.00
Alpine Elm	FBP17.AE	£244.00
Charcoal Elm	FBP17.CE	£244.00
Gloss Dark Clay	FBP17.GDC	£244.00
Flintwood	FBP17.FW	£244.00
Natural Oak	FBP17.OK	£244.00
Washed Oak	FBP17.WO	£244.00
White	FBP17.W	£244.00
Vetro White	FBP17.VW	£244.00
Vetro Cinder	FBP17.VC	£244.00
Vetro Grey	FBP17.VG	£244.00
Mercury	FBP17.MY	£244.00
Chalk White	FBP17.CW	£244.00
Mocha	FBP17.MC	£244.00
Pebble Grey	FBP17.PG	£244.00
Slate Grey	FBP17.SG	£244.00

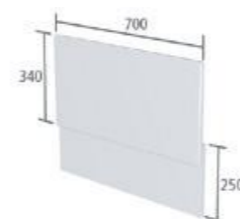

700mm end bath panel with plinth

- Nominal height from underside of bath to floor 520mm, this gives plinth height of 180mm to match furniture
- Plinth can be screwed to panel from rear
- Maximum height 570mm
- Styles vary according to range

Finish	Code	Price
Derwent Blue	FBP7.DB	£97.10
Alpine Elm	FBP7.AE	£97.10
Charcoal Elm	FBP7.CE	£97.10
Gloss Dark Clay	FBP7.GDC	£97.10
Flintwood	FBP7.FW	£97.10
Natural Oak	FBP7.OK	£97.10
Washed Oak	FBP7.WO	£97.10
White	FBP7.W	£97.10
Vetro White	FBP7.VW	£97.10
Vetro Cinder	FBP7.VC	£97.10
Vetro Grey	FBP7.VG	£97.10
Mercury	FBP7.MY	£97.10
Chalk White	FBP7.CW	£97.10
Mocha	FBP7.MC	£97.10
Pebble Grey	FBP7.PG	£97.10
Slate Grey	FBP7.SG	£97.10





Bath panel corner post

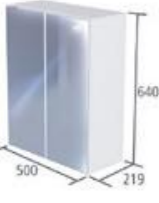
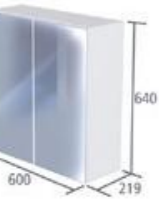

- Use on ends of white panels to increase length of panel from 1700mm to 1750mm, 1800mm etc to suit different bath sizes
- Allows neat joint between front and end panels
- Cut to height of bath

Finish	Code	Price
Derwent Blue	FBCP6.DB	£61.80
Mercury	FBCP6.MY	£61.80
Chalk White	FBCP6.CW	£61.80
Mocha	FBCP6.MC	£61.80
Pebble Grey	FBCP6.PG	£61.80
Slate Grey	FBCP6.SG	£61.80
Gloss Dark Clay	FBCP6.GDC	£61.80
White	FBCP6.W	£61.80

CABINETS

		Finish	Code	Price
	300mm single door mirrored cabinet	Natural Oak White Silver Graphite	F2MWC3.OK F2MWC3.W F2MWC3.G F2MWC3.D	£318.00 £318.00 £318.00 £318.00
	<ul style="list-style-type: none"> • Push-to-open door • Reversible door • Two glass shelves • Push pad to stop finger marks 			
	500mm double door mirrored cabinet	Natural Oak White Silver Graphite	F2MWC5.OK F2MWC5.W F2MWC5.G F2MWC5.D	£394.00 £394.00 £394.00 £394.00
	<ul style="list-style-type: none"> • Push-to-open door • Two glass shelves • Void in rear for electrical transformer to be concealed • Push pad to stop finger marks 			
	600mm double door mirrored cabinet	Natural Oak White Silver Graphite	F2MWC6.OK F2MWC6.W F2MWC6.G F2MWC6.D	£428.00 £428.00 £428.00 £428.00
	<ul style="list-style-type: none"> • Push-to-open door • Two glass shelves • Void in rear for electrical transformer to be concealed • Push pad to stop finger marks 			
	700mm double door mirrored cabinet	Natural Oak White Silver Graphite	F2MWC7.OK F2MWC7.W F2MWC7.G F2MWC7.D	£445.00 £445.00 £445.00 £445.00
	<ul style="list-style-type: none"> • Push-to-open door • Two glass shelves • Void in rear for electrical transformer to be concealed • Push pad to stop finger marks 			

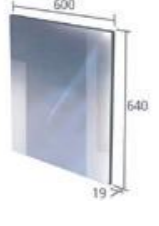

MIRRORS

	Air 560mm backlit mirror		FBM560	£337.00
	<ul style="list-style-type: none"> • Heated demister mirror pad • Infrared touchless switching • Recharger socket • Backlit fluorescent light 			
	500mm mirror		FM500	£146.00
	<ul style="list-style-type: none"> • Silver coloured edging to match all designs/finishes • Can be mounted flush or 25mm from wall to allow electrical lighting transformer to be concealed 			
	600mm mirror		FM600	£257.00
	<ul style="list-style-type: none"> • Silver coloured edging to match all designs/finishes • Can be mounted flush or 25mm from wall to allow electrical lighting transformer to be concealed • Heated demister pad - can be connected into lighting circuit to be switched when lighting is turned on and off 			

MIRRORS

		Finish	Code	Price
	700mm mirror		FM700	£274.00
	<ul style="list-style-type: none"> • Silver coloured edging to match all designs/finishes • Can be mounted flush or 25mm from wall to allow LED light driver to be concealed • Heated demister pad - can be connected into lighting circuit to be switched when lighting is turned on and off 			

LIGHTING

	300mm Chrome LED light	Chrome	LED300WL	£60.10
	<ul style="list-style-type: none"> • For use on top of cabinets or mirrors • 6 watt LED light • Light is IP44 rated • Supplied with driver suitable for mounting outside bathroom zones 1 & 2 - behind mirror or cabinet 			
	LED Sweep Chrome Light	Chrome	LED5WL	£48.20
	<ul style="list-style-type: none"> • For use on top of cabinets or mirrors • 3 watt LED light • Light is IP44 rated • Supplied with driver suitable for mounting outside bathroom zones 1 & 2 - behind mirror or cabinet 			





SANITARYWARE

Back To Wall & Wall Hung WCs & Toilet Seats

	Accent 510mm back to wall WC (excluding toilet seat)	White	ABWPAN	£339.00
	<ul style="list-style-type: none"> 510mm projection Horizontal outlet Concealed fixings for anchoring to floor Top fix design for use with Accent soft close toilet seat (sold separately) 			
	Accent 505mm wall hung WC (excluding toilet seat)	White	AWHPAN	£339.00
	<ul style="list-style-type: none"> 505mm projection Horizontal outlet Top fix design for use with Accent soft close toilet seat (sold separately) Must be mounted on specialist fixing frame - See page 120 			
	Accent soft close toilet seat	White	ASCTS	£80.60
	<ul style="list-style-type: none"> Soft Close Quick Release Top fix seat design Wrap over design 			
	Cover 530mm back to wall WC (excluding toilet seat)	White	CBWPAN	£339.00
	<ul style="list-style-type: none"> 530mm projection Horizontal outlet Concealed fixings for anchoring to floor Top fix design for use with Cover soft close toilet seat (sold separately) 			
	Cover 525mm wall hung WC (excluding toilet seat)	White	CWHPAN	£339.00
	<ul style="list-style-type: none"> 525mm projection Horizontal outlet Top fix design for use with Cover soft close toilet seat (sold separately) Must be mounted on specialist fixing frame - See page 120 			
	Cover soft close toilet seat	White	CSCTS	£80.60
	<ul style="list-style-type: none"> Soft Close Quick Release Top fix seat design Wrap over design 			
	Harrow 520mm back to wall WC (excluding toilet seat)	White	HBWPAN	£228.50
	<ul style="list-style-type: none"> 520mm projection Horizontal outlet Top fix design for use with the Harrow seat (shown) or the Minerva soft close toilet seat (both sold separately) Concealed fixings for anchoring to floor 			
	Harrow soft close toilet seat	White	HSCTSW	£111.00
	<ul style="list-style-type: none"> Suitable for use with Harrow back to wall WC Top fix or under fix High gloss white painted wooden seat Chrome soft close bar hinge 			
	Note 500mm back to wall WC (excluding toilet seat)	White	NBWPAN	£409.00
	<ul style="list-style-type: none"> 500mm projection Horizontal outlet Top fix seat design Concealed fixings for anchoring to floor 			

SANITARYWARE

Back To Wall & Wall Hung WCs & Toilet Seats







	Note 500mm wall hung WC (excluding toilet seat)	White	NWHPAN	£409.00
	<ul style="list-style-type: none"> 500mm projection Horizontal outlet Must be mounted on specialist fixing frame - See page 120 Concealed fixings with 180mm spaced fixing centres 			
	Note soft close toilet seat	White	8704WSC	£59.60
	<ul style="list-style-type: none"> Suitable for use with Note back to wall and wall hung WCs Top fix, soft close, quick release hinges Thermoset seat Wrap over style Anti-bacterial protection 			
	Note slim soft close toilet seat	White	NLSCTS	£86.00
	<ul style="list-style-type: none"> Suitable for use with Note back to wall and wall hung WCs Top fix, soft close, quick release hinges Thermoset seat Slim seat design Anti-bacterial protection 			
	Zest 500mm back to wall WC	White	ZBWPAN50	£298.00
	<ul style="list-style-type: none"> 500mm projection Horizontal outlet Top fix design for use with Zest 500mm toilet seat (sold separately) Concealed fixings for anchoring to floor 			
	Zest 500mm wall hung WC	White	ZWHPAN50	£328.00
	<ul style="list-style-type: none"> 500mm projection Horizontal outlet Top fix design for use with Zest 500mm toilet seat (sold separately) Concealed fixings with 180mm spaced fixing centres Must be mounted on specialist fixing frame - See page 120 			
	Zest 500mm soft close toilet seat	White	ZSCTS50	£146.00
	<ul style="list-style-type: none"> Suitable for use with - 500mm Zest back to wall and wall hung WCs and Zest close coupled WC Top fix design Thermoset seat Wrap over style Chrome soft close hinges 			
	Zest 450mm short projection back to wall WC	White	ZBWPAN45	£278.00
	<ul style="list-style-type: none"> 450mm ultra short projection Horizontal outlet Top fix design for use with Zest 450mm toilet seat (sold separately) Concealed fixings for anchoring to floor 			
	Zest 450mm short projection soft close toilet seat	White	ZSCTS45	£146.00
	<ul style="list-style-type: none"> Suitable for use with 450mm Zest short projection back to wall WC Top fix design Thermoset seat Wrap over style Chrome soft close hinges Quick release 			

SANITARYWARE

Back To Wall & Wall Hung WCs & Toilet Seats	Finish	Code	Price
 <p>Minerva 530mm comfort height back to wall WC (excluding toilet seat)</p> <ul style="list-style-type: none"> 530mm projection Horizontal outlet Top fix design for use with Minerva or Juno soft close toilet seat (sold separately) Use with TR9008 comfort height cistern 	White	MBWCHP	£187.00
 <p>Minerva 515mm back to wall WC</p> <ul style="list-style-type: none"> 515mm projection Top fix design for use with Minerva & Juno toilet seats (sold separately) Concealed fixings for anchoring to floor 	White	MBWPAN	£150.50
 <p>Minerva soft close toilet seat</p> <ul style="list-style-type: none"> Suitable for use with Minerva back to wall WC and Minerva close coupled pan Quick release Anti-bacterial Top fix design Thermoset seat 	White	MSCTS	£76.20
 <p>Juno soft close seat</p> <ul style="list-style-type: none"> Suitable for use with Minerva back to wall WC and Minerva close coupled pan Quick release Anti-bacterial Top fix design Thermoset seat 	White	8703WSC	£59.60
 <p>Geo 505mm back to wall WC</p> <ul style="list-style-type: none"> 505mm projection Horizontal outlet Top fix design for use with Geo 505mm toilet seat (sold separately) 	White	GBWPAN	£208.00
 <p>Geo 505mm soft close toilet seat</p> <ul style="list-style-type: none"> Suitable for use with Geo back to wall WC and Geo close coupled WC Top fix design Thermoset seat Chrome soft close hinges Quick release 	White	GSCTS	£79.90
 <p>Accent 630mm close coupled fully enclosed WC</p> <ul style="list-style-type: none"> 630mm short projection Dual flush fittings included Top fix design for use with Accent toilet seat (sold separately) 4.5/3L flush <p>Total £537.00</p>	White	ACCPAN ACCTNK	£339.00 £198.00







Close Coupled WCs

SANITARYWARE

Close Coupled WCs	Finish	Code	Price
 <p>Cover 660mm close coupled fully enclosed WC</p> <ul style="list-style-type: none"> 660mm projection Supplied with internal plastic anti-condensation tank & ceramic lidless cistern Top fix design for use with Cover toilet seat (sold separately) 6/3L flush <p>Total £503.00</p>	White	CCCPAN CCCTNK	£339.00 £164.00
 <p>Note 620mm close coupled WC</p> <ul style="list-style-type: none"> 620mm short projection Dual flush fittings included Top fix design for use with Note toilet seat (sold separately) 120mm side void 4.5/3L flush <p>Total £651.00</p>	White	NCCPAN2 NCCTNK2	£412.00 £239.00
 <p>Note 620mm close coupled fully enclosed WC</p> <ul style="list-style-type: none"> 620mm short projection Dual flush fittings included Top fix design for use with Note toilet seat (sold separately) 4.5/3L flush <p>Total £697.00</p>	White	NCCPAN NCCTNK	£458.00 £239.00
 <p>Zest close coupled fully enclosed WC</p> <ul style="list-style-type: none"> 655mm projection Top fix design for use with Zest toilet seat (sold separately) Concealed fixings for anchoring to floor 6/3L flush <p>Total £607.00</p>	White	ZCCPAN65 ZCCTNK	£358.00 £249.00
 <p>Minerva close coupled WC</p> <ul style="list-style-type: none"> 665mm projection Top fix design for use with Minerva & Juno toilet seats (sold separately) Concealed fixings for anchoring to floor 4.5/2.8L flush - Adjustable 6/4L flush <p>Total £324.50</p>		MCCPAN MCCTNK	£208.50 £116.00
 <p>Geo close coupled WC</p> <ul style="list-style-type: none"> 655mm projection Top fix design for use with Geo toilet seat (sold separately) Concealed fixings for anchoring to floor 130mm side void 6/4L flush <p>Total £362.50</p>	White	GCCPAN2 GCCTNK	£247.50 £115.00
 <p>Geo close coupled fully enclosed WC</p> <ul style="list-style-type: none"> 655mm projection Top fix design for use with Geo toilet seat (sold separately) Concealed fixings for anchoring to floor 6/4L flush <p>Total £389.00</p>	White	GCCPAN GCCTNK	£274.00 £115.00











SANITARYWARE

Wall Hung Frames & Cisterns

	Finish	Code	Price
 <p>0.82m Wall Hung WC Frame - For use with furniture installations</p> <ul style="list-style-type: none"> 0.82m high to enable use within 600mm & wider furniture WC units 500mm width, 167-215mm adjustable depth WRAS approved 6/3L pneumatic flush valve and side entry 1/2" (female) inlet valve Top & front access options Polystyrene anti condensation jacket 0.2-10bar working pressure range Brackets, fixings & 1st fix protective covers included Requires flush plate/button/contactless sensor. See page 121 <p>Furniture Adapter Kit for 0.82m Wall Hung WC Frame</p> <ul style="list-style-type: none"> Use with the 0.82m Wall Hung WC Frame when in furniture installations 		TR9005	£234.50
 <p>1.0m Wall Hung WC Frame - Ideal for installation under windows</p> <ul style="list-style-type: none"> 1.0m high for in-wall applications 500mm width, 167-215mm under window adjustable depth WRAS approved 6/3L pneumatic flush valve and side entry 1/2" (female) inlet valve Top & front access options Polystyrene anti condensation jacket 0.2-10bar working pressure range Brackets, fixings & 1st fix protective covers included Requires flush plate/button/contactless sensor. See page 121 		TR9015	£222.00
 <p>1.17m Wall Hung WC Frame - For in-wall installations</p> <ul style="list-style-type: none"> 1.17m high for in-wall applications 500mm width, 140-200mm adjustable depth WRAS approved 6/3L pneumatic flush valve & top entry 1/2" (male) inlet valve Front access Polystyrene anti condensation jacket 0.2-10bar working pressure range Brackets, fixings & 1st fix protective covers included Requires flush plate/button/contactless sensor. See page 121 	White	TR9006	£234.50
 <p>0.4m Half Height WC/Bidet Frame</p> <ul style="list-style-type: none"> 0.4m high compact WC frame Only 400mm wide, so it is suitable for narrow 500mm back to wall unit applications Can also be used for bidets Compatible with both slim & standard depth furniture For use with Torrent, Cascade or comfort height cisterns see page 121 	White	TR9018	£108.50
 <p>In-Wall cistern</p> <ul style="list-style-type: none"> Ideal for fully tiled in installations All parts serviceable through flush plate aperture Internal isolation valve 150mm height adjustment Top or front flush plate mounting Dual flush (6/3 litres) WRAS approved pneumatic flush valve WRAS approved side entry inlet valve (1/2" female BSP) Push plate or contactless sensor required see page 121 	White	TR9009	£107.50
 <p>Torrent concealed dual flush cistern</p> <ul style="list-style-type: none"> Bottom entry Dual flush (6/3 litres) Chrome effect pneumatic button included or use with optional push button/push plate or contactless sensor see page 121 Water supply connection at bottom left: 1/2" BSP WRAS approved 	White	TR9001	£94.60

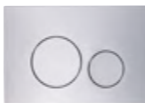
SANITARYWARE





Wall Hung Frames & Cisterns

	Finish	Code	Price
 <p>Cascade concealed dual flush cistern</p> <ul style="list-style-type: none"> Side entry Dual flush (6/3 litres) Chrome effect pneumatic button included or use with optional push button/flush plate or contactless sensor (see page 121) Water supply connection at side left: 1/2" BSP WRAS approved 	White	TR9002	£94.60
 <p>Comfort Height cistern</p> <p>Developed specifically to allow comfort height back to wall pans to be used in 820mm high furniture</p> <ul style="list-style-type: none"> Dual flush (6/3 litres) WRAS approved pneumatic flush valve WRAS approved bottom entry inlet valve Chrome effect pneumatic button included or use with optional square push button or contactless sensor (see page 121) Not compatible with flush plates 	White	TR9008	£94.60
 <p>Touch sensor dual flush plate</p> <ul style="list-style-type: none"> Activated by the lightest touch Dual flush Best for use with wall hung WC frames If used within furniture, suitable for standard depth only Battery operated (4 x AA batteries) 	Black	TR9016	£129.00
 <p>Traditional flush plate</p> <ul style="list-style-type: none"> Pneumatic dual flush push plate Compatible with wall hung frames & in-wall cisterns White traditional indicies 	Chrome	TR9017	£41.80
 <p>Plaza flush plate</p> <ul style="list-style-type: none"> Pneumatic dual flush push plate Compatible with wall hung frames & in-wall cisterns 	Chrome	TR9010	£36.20
 <p>Plaza flush plate</p> <ul style="list-style-type: none"> Pneumatic dual flush push plate Compatible with wall hung frames & in-wall cisterns 	White	TR9011	£27.70
 <p>Rondo flush plate</p> <ul style="list-style-type: none"> Pneumatic dual flush push plate Compatible with wall hung frames & in-wall cisterns 	Chrome	TR9012	£36.20
 <p>Rondo flush plate</p> <ul style="list-style-type: none"> Pneumatic dual flush push plate Compatible with wall hung frames & in wall cisterns 	White	TR9013	£27.70
 <p>Ellipse flush Plate</p> <ul style="list-style-type: none"> Pneumatic dual flush push plate Compatible with wall hung frames & in-wall cisterns 	Chrome	TR9004	£36.20
 <p>Square flush Button</p> <ul style="list-style-type: none"> Pneumatic dual flush push plate Compatible with concealed cisterns If used with wall hung frames provision must be made for access in lieu of flush plate 	Chrome	TR9003	£11.10
 <p>Cistern contactless dual flush remote sensor kit</p> <ul style="list-style-type: none"> Touchless flush activation Dual flush Best for use with concealed cisterns Battery operated (4 x AA batteries) Provision must be made for access if installed in-wall 	Black	TR9014	£107.50

Note: Due to the depth of the comfort height cistern it is not compatible with the use of flush plates in furniture installations

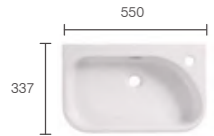

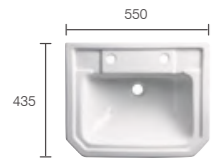
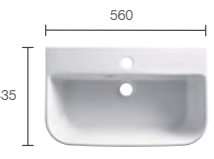
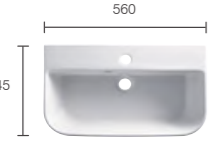
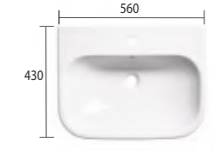
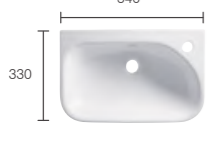

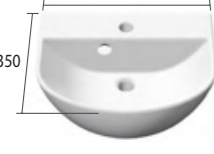
SANITARYWARE

Semi-Countertop Basins







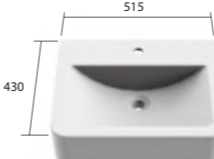
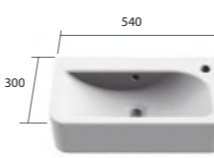

	Finish	Code	Price
 <p>Accent 560mm semi-countertop basin 1 tap hole</p> <ul style="list-style-type: none"> • Suitable for use with standard depth furniture • Supplied with cutting template for worktop and fascia • Monobloc tap hole & overflow • Minimum furniture depth 293mm 	White	A3SCBAS	£268.00
 <p>Accent 550mm slim depth semi-countertop basin 1 tap hole</p> <ul style="list-style-type: none"> • Suitable for use with standard depth furniture • Supplied with cutting template for worktop and fascia • Monobloc tap hole & overflow • Minimum furniture depth 218mm 	White	A2SCBAS	£253.00
 <p>Harrow semi-countertop basin 1 tap hole</p> <ul style="list-style-type: none"> • Suitable for use with standard depth furniture • Supplied with cutting template for worktop and fascia • Monobloc tap hole & overflow • Minimum furniture depth 270mm 	White	H3SCBAS1	£181.50
 <p>Harrow semi-countertop basin 2 tap holes</p> <ul style="list-style-type: none"> • Suitable for use with standard depth furniture • Supplied with cutting template for worktop and fascia • Monobloc tap hole & overflow • Minimum furniture depth 270mm 	White	H3SCBAS2	£181.50
 <p>Cover 560mm semi-countertop basin</p> <ul style="list-style-type: none"> • Suitable for use with standard depth furniture • Minimum furniture depth 290mm 	White	C3SCBAS	£204.50
 <p>Cover 560mm slim semi-countertop basin</p> <ul style="list-style-type: none"> • Suitable for use with slim depth furniture • Wall mounted or countertop basin • Minimum furniture depth 218mm 	White	C2SCBAS	£193.00
 <p>Note 560mm semi-countertop basin</p> <ul style="list-style-type: none"> • Suitable for use with standard depth furniture • Supplied with cutting template for worktop and fascia • Monobloc tap hole & overflow • Minimum furniture depth 300mm 	White	N3SCBAS	£284.00
 <p>Note 540mm slim depth semi-countertop basin</p> <ul style="list-style-type: none"> • Suitable for use with slim depth furniture • Supplied with cutting template for worktop and fascia • Monobloc tap hole & overflow • Minimum furniture depth 215mm 	White	N2SCBAS	£269.00
 <p>Zest 500mm semi-countertop basin</p> <ul style="list-style-type: none"> • Suitable for use with standard depth furniture • Supplied with cutting template for worktop and fascia • Monobloc tap hole & overflow • Minimum furniture depth 250mm 	White	Z3SCBAS	£272.00
 <p>Zest 435mm slim depth semi-countertop basin</p> <ul style="list-style-type: none"> • Suitable for use with slim depth furniture • Supplied with cutting template for worktop and fascia • Monobloc tap hole & overflow • Minimum furniture depth 210mm 	White	Z2SCBAS	£239.50

SANITARYWARE

Semi-Countertop Basins

	Finish	Code	Price
 <p>Minerva 560mm semi-countertop basin</p> <ul style="list-style-type: none"> • Suitable for use with standard depth furniture • Supplied with cutting template for worktop and fascia • Monobloc tap hole & overflow • Minimum furniture depth 240mm 	White	M3SCBAS	£142.00
 <p>Minerva 535mm slim depth semi-countertop basin</p> <ul style="list-style-type: none"> • Suitable for use with slim depth furniture • Supplied with cutting template for worktop and fascia • Monobloc tap hole & overflow • Minimum furniture depth 218mm 	White	M2SCBAS	£124.50
 <p>Minerva 460mm slim depth semi-countertop basin</p> <ul style="list-style-type: none"> • Suitable for use with slim depth furniture • Supplied with cutting template for worktop and fascia • Monobloc tap hole & overflow • Minimum furniture depth 218mm • Ideal for use in 500mm wide basin units 	White	M2SCBAS46	£124.50
 <p>Geo 500mm semi-countertop basin</p> <ul style="list-style-type: none"> • Suitable for use with standard depth furniture • Supplied with cutting template for worktop and fascia • Monobloc tap hole & overflow • Minimum furniture depth 255mm • Ideal for use in 500mm wide basin units for 1m runs 	White	G3SCBAS50	£167.50
 <p>Geo 515mm semi-countertop basin</p> <ul style="list-style-type: none"> • Suitable for use with standard depth furniture • Supplied with cutting template for worktop and fascia • Monobloc tap hole & overflow • Minimum furniture depth 320mm 	White	G3SCBAS	£181.50
 <p>Geo 540mm slim depth semi-countertop basin</p> <ul style="list-style-type: none"> • Suitable for use with slim depth furniture • Monobloc tap hole & overflow • Minimum furniture depth 218mm 	White	G2SCBAS	£167.50





TAPS

Basin Mixers	Finish	Code	Price
 <p>Hydra basin mixer with click waste</p> <ul style="list-style-type: none"> • Minimum pressure 0.2bar 	Chrome	T151102	£157.00
 <p>Hydra basin mixer with click waste</p> <ul style="list-style-type: none"> • Minimum pressure 0.2bar 	Black	T151103	£157.00
 <p>Hydra basin mixer with click waste</p> <ul style="list-style-type: none"> • Minimum pressure 0.2bar 	Brass	T151104	£157.00
 <p>Elate basin mixer with click waste</p> <ul style="list-style-type: none"> • Minimum pressure 0.5bar 	Chrome	T241102	£178.50
 <p>Elate basin mixer with click waste</p> <ul style="list-style-type: none"> • Minimum pressure 0.5bar 	Black	T241103	£178.50
 <p>Elate basin mixer with click waste</p> <ul style="list-style-type: none"> • Minimum pressure 0.5bar 	Brass	T241104	£178.50
 <p>Aim basin mixer with click waste</p> <ul style="list-style-type: none"> • Minimum pressure 0.2bar 	Chrome	T291102	£118.50
 <p>Veer basin mixer with click waste</p> <ul style="list-style-type: none"> • Minimum pressure 0.2bar 	Chrome	T301102	£134.00
 <p>Verse basin mixer with click waste</p> <ul style="list-style-type: none"> • Minimum pressure 0.2bar 	Chrome	T271102	£130.00

TAPS

Basin Mixers	Finish	Code	Price
 <p>Poise basin mixer with click waste</p> <ul style="list-style-type: none"> • Minimum pressure 1.0bar 	Chrome	T231102	£193.50
 <p>Sign open spout basin mixer with click waste</p> <ul style="list-style-type: none"> • Minimum pressure 1.0bar 	Chrome	T171102	£169.00
 <p>Stream basin mixer with click waste</p> <ul style="list-style-type: none"> • Minimum pressure 0.1bar 	Chrome	T771002	£160.00
 <p>Code basin mixer with click waste</p> <ul style="list-style-type: none"> • Minimum pressure 0.5bar 	Chrome	T191102	£148.50
 <p>Image basin mixer with click waste</p> <ul style="list-style-type: none"> • Minimum pressure 0.5bar 	Chrome	T181102	£148.50
 <p>Sync basin mixer with click waste</p> <ul style="list-style-type: none"> • Minimum pressure 0.5bar 	Chrome	T201102	£148.50
 <p>Insight basin mixer with click waste</p> <ul style="list-style-type: none"> • Minimum pressure 0.1bar 	Chrome	T991002	£142.50
 <p>Factor basin mixer with click waste</p> <ul style="list-style-type: none"> • Minimum pressure 0.1bar 	Chrome	T131102	£142.00

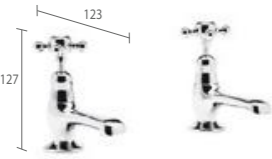
TAPS

Basin Mixers	Finish	Code	Price
 <p>Storm basin mixer with click waste</p> <ul style="list-style-type: none"> Minimum pressure 0.1bar 	Chrome	T221002	£125.00
 <p>Henley basin mixer with pop up waste</p> <ul style="list-style-type: none"> Minimum pressure 0.1bar 	Chrome	T261102	£149.00
 <p>Henley basin taps (pair)</p> <ul style="list-style-type: none"> Minimum pressure 0.1bar 	Chrome	T267002	£91.20
 <p>Wessex basin mixer with click waste</p> <ul style="list-style-type: none"> Minimum pressure 0.1bar 	Chrome	T661002	£202.00

PLANNING TIPS AND ADVICE

LOCATING THE MAIN ITEMS

Wherever possible, try and install your WC, basin, bath and/or shower in a similar position to that in your current bathroom in order to minimise installation time and costs.

Planning - Key Steps

- Measure your bathroom and draw out a plan, to scale if possible.
- Make reference to where all services are located including soil pipes and water inlets.
- Ensure all dimensions of heights/widths of windows and radiator positions are marked up on your plan.
- Take note of the direction the door opens as this could affect your layout. If it is a hindrance, your door could easily be re-hung by a professional to allow more flexibility.

Once you have the outline of your bathroom, you can experiment by placing different units within your plan. See page 7 for full details of the different sized units available. If you have an odd space at one end of a run of furniture, for example if fitting between two walls or a wall and a bath, then filler panels can be used. The worktop can run across the top of the furniture between the two walls to create a continuous look. Roper Rhodes storage shelf units are supplied in a flat pack format, allowing your installer to cut down the width of the shelves and base components from the nominal 300mm width so that the unit can be customised to suit any size.

When you are happy with your initial design layout, take it to your Roper Rhodes stockist. Your retailer may come up with some further design ideas which may help inspire you.

Corners

If due to the size of your room there is an odd space, then two pieces of filler panel can be used to space the units as necessary.

Worktops can be fitted together on top of your corner configuration using a mason's mitre jig and worktop jointing bolts. Your bathroom fitter will be able to advise further.

WC Units

The use of a WC unit and concealed cistern can create a clean uncluttered look for your bathroom. Dual flush concealed cisterns available from Roper Rhodes operate by a pneumatic push button which can be sited in the front removable fascia of the WC unit, or on the top of the unit if desired.* Our WC units feature a panel which goes to the floor, removing the need for unsightly filler blocks that are sometimes used to fill the void between the back to wall WC pan and the plinth. As a consequence, it is recommended that when fitting commences, the WC unit height is set first with the other units running off. If the floor of the installation is uneven, then the main fascia panel can be scribed to fit.

If a wall hung WC pan is required, then a suitable supporting frame must be used see page 71. Never fit a wall hung pan directly to the fascia of a WC unit only. Speak to your retailer for more details on compatibility.

Basins

Roper Rhodes semi-countertop basins are available in both slim and standard depth formats and can be mounted on both laminate and solid surface worktops by an experienced fitter.

Slim Depth Furniture

The key units within the Roper Rhodes Fitted Furniture range are available in both standard and slimline formats. Using slimline furniture in small ensuites or cloakrooms can help maintain vital space in the room without sacrificing bathroom storage.

* Only with standard depth WC units. Flush buttons can only be installed on the front fascia of slimline units.

PLANNING TIPS AND ADVICE

Concealing Pipework

One of the benefits of using Roper Rhodes Fitted Furniture is that unsightly pipework can run along skirting boards and walls whilst being concealed behind the units. The furniture is designed with a plinth height of 180mm, which means that even soil pipes can run under the units. Should long runs feature a greater angle of fall, or if the installation has an old soil pipe outlet which is slightly higher, then 50mm extension legs are available for use with 230mm bridging panels (which can also be used in place of standard sized plinths). This will mean that you will have 50mm of plinth visible along the bottom of the WC unit fascia panel.

All standard depth base units feature a generous 50mm void at the back, which allows waste pipes and copper pipes to run along the walls whilst being concealed behind the units. Your fitter will only have to notch out the side panel of the unit where the pipe traverses. In addition to the 50mm pipe void, basin units in both slim and standard depth configurations feature a removable back panel to aid the installation process. (See diagrams below).

Electrics

When planning your bathroom, note where any lighting or electrical supply cables are situated. It may be necessary to move these. It is advised that this work is done after the old bathroom fittings are removed but before the new installation begins. Always use a qualified electrician for any work carried out in a bathroom. Your retailer may be able to advise when to schedule an electrician, or consult your fitter or electrician for more advice. Please note that Roper Rhodes cannot give specific advice on electrical installations.

When planning where to locate lighting, it is vital that the IP rating of the device is taken into account as this will affect which zone of the bathroom the fitting can be located in. Your electrician will be able to advise further on bathroom zones and which electrical appliances can be sited where. Remember to allow for the provision of switching for any new lighting.

It is recommended that, whilst you are at the planning stage, you make an allowance for the installation of a suitable extractor fan to remove excess water from the atmosphere. After the furniture has been fitted, plan for an electrician to come back and install light fittings or electrical devices which are used.

Mirrors

Roper Rhodes mirrors (over 560mm wide) feature heated mirror pads to prevent them from misting up. Your electrician can connect the heated mirror pad to the domestic supply so that the pad is switched on and off when your bathroom lighting is operated. Heater pads should not be connected to a permanently live supply. Please note, mirrors must never be installed above a bath or shower.

Plumbing Voids

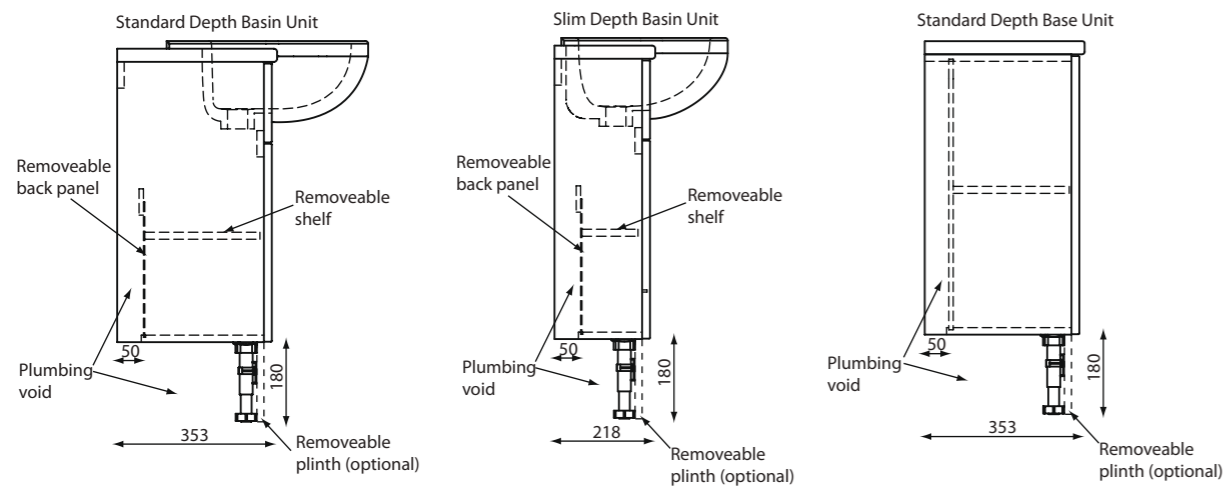

PLANNING TIPS AND ADVICE

Filler Panels

Filler panels are available to fill gaps at the ends of runs of furniture and to clad ends of furniture for a perfect match.

Accent Panels

Accent panels are available in slim and standard depth configurations and are 30mm thick (with the exception of the smoked oak panel which is 25mm thick) to give a different look to your bathroom installation. By cladding these to the sides of units, a framed look can be achieved. Use the universal pelmet/cornice along the bottoms of units to create the impression that a longer accent panel has been fitted to create a framed look. Accent panels are 820mm tall, allowing them to run from the floor to the underside of the worktop if necessary. They can be cut down if base units are wall hung. The slim design panels can also be cut down to be used with wall cabinets or wall cupboards.

You can achieve very different effects by contrasting the panels and fascias of units. Matching colours between doors and accent panels creates a subtle yet 'solid framed' look.

Handles

The comprehensive range of handles in the Roper Rhodes range allows a multitude of looks to be created. Move them into different positions on the door, or change their orientation, to create the look you want on your furniture.

Please note that all doors will require your fitter to drill and fit your handles so that you can position them exactly where you want.

Bath Panels

Designed to complement all door styles. Both front and end panels are supplied with a matching plinth which allows for adjustment depending on site conditions. To achieve a continuous look between the furniture and the bath panel, it is recommended that the panel is set at a height of 520mm, so that a plinth height of 180mm is achieved.

Note: Once installed all bath panels must be sealed along the top, bottom and sides with a suitable silicone sealant to prevent damage from excessive moisture.

Corner Posts (For Bath Panels)

Designed to provide a neat joint on an exposed corner of a bath between front and end panels. The corner posts can also be used to allow larger sized bath tubs to be accommodated with the panels available in the range. A corner post will add 50mm in length to a panel, so using two corner posts would allow an 1800mm tub to be installed.

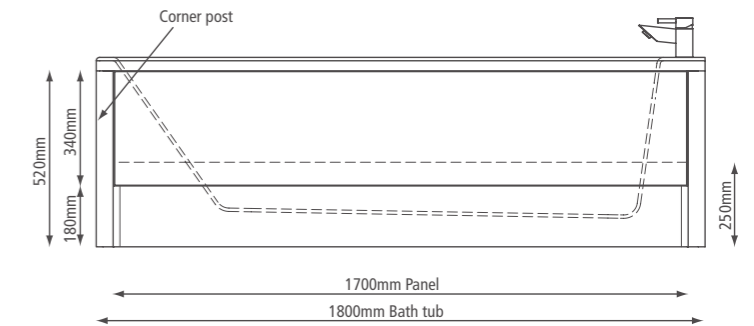

TERMS & CONDITIONS

Roper Rhodes Fitted Furniture must be installed by a qualified fitter. In the unlikely event that your product is damaged or faulty in any way, this must be notified on receipt, and must not under any circumstances be fitted. Time must be allowed between delivery and installation for checking items and the delivery of subsequent replacements. Attention is drawn to the policy of replacing any damaged part with a spare part where possible. Complete exchanges will only be made if damage is excessive. We shall not be liable for any further unfitting/refitting costs or financial compensation. Components/products that are deemed defective as a result of incorrect or substandard installation or improper or negligent use will be excluded from any guarantee claim. Roper Rhodes Ltd reserve the right to amend specifications at any time if an opportunity to further improve the product occurs.

All dimensions are approximate, especially with ceramic sanitaryware where a tolerance of +/- 2% must be allowed.

Doors and fascias are supplied separately to the furniture units, to prevent them from being damaged during the installation process. Doors are simply fixed by your fitter screwing the necessary hardware to the backs of the doors or fascias and simply clicking into place on the relevant hinge plate inside the unit. Mirror glass cabinets are supplied with doors installed. Doors are supplied un-drilled for handles due to the wide variety of handles and possible positions. Any competent fitter will be able to fit them in the positions which best suit the design of your individual bathroom. All units are supplied assembled with the exception of the storage shelf units (which can be modified if necessary to fit a smaller gap) and the mirror shelf unit.

All timber finishes featured within this brochure are timber effect. Please note that there may be some slight variation between carcasses, doors and worktops due to different manufacturing techniques used.

Roper Rhodes bathroom furniture is designed for use within domestic installations which are adequately ventilated. As with any timber product, bathroom furniture will be adversely affected if it is subjected to excessive moisture. It is strongly recommended that adequate bathroom extractor fans are installed to prevent heavy condensation and all splashes and spillages must be mopped dry as soon as possible. All exposed or cut surfaces must be sealed with a suitable varnish or silicone sealant to prevent blowing. If this is not done, all guarantee claims will be void. In particular, silicone sealant must be used around basins and worktop joints, and around all edges of bath panels and plinths if the sealer strip is not utilised. All electrical products should be installed by an approved electrician in line with current wiring regulations. Guarantees are for domestic use only and not transferable.

ACKNOWLEDGEMENTS

Viewpoint photography - viewpoint-photography.co.uk - 01761 420841
Porcelanosa - porcelanosa.co.uk - 0800 915 4000
Mandarin Stone - mandarinstone.com - 01600 715 444
The Radiator Co. - theradiatorcompany.co.uk - 01342 302250
Iconic - iconicradiators.co.uk - 01342 305579

The colours within the photography of this brochure may sometimes not be a true representation of the actual product due to the printing and reproduction methods used.

As one of the UK's largest suppliers of bathroom furniture and accessories, we set very high standards in design, manufacture and service. We also invest heavily in product improvement and innovation to ensure complete customer satisfaction. Roper Rhodes will make every effort to supply all products ordered in as short a lead time as possible. Roper Rhodes standard delivery is three days. Should you require next day delivery this can be arranged.

HOW TO CONTACT US...

If you need to contact us, our experienced in-house customer service team has a wealth of knowledge about our products.

Telephone - 01225 303900

Lines open

Monday to Thursday - 9:00am - 5:30pm

Friday - 9:00am - 5:00pm

Email - sales@roperrhodes.co.uk

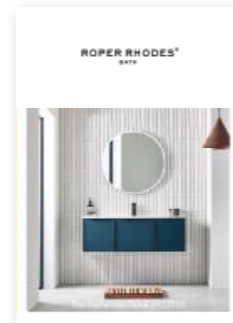

THE BATHROOM BOOK

To view the full collection of Roper Rhodes bathroom products please ask your retailer for a copy of The Bathroom Book or visit roperrhodes.co.uk



